

Park Row

The proactive estate agent



Great North Road, South Milford, Leeds, LS25 5LJ

Offers In Excess Of £450,000



****DETACHED FAMILY HOME ON A SUBSTANTIAL PLOT**FOUR BEDROOMS**OFF STREET PARKING**SIZEABLE REAR GARDEN**GARAGE**OUTBUILDINGS**ORIGINAL FEATURES THROUGHOUT**TWO EN-SUITES**DOWNSTAIRS W/C**UTILITY**MASTER BEDROOM WITH A DRESSING AREA****

Nestled on the Great North Road in South Milford, Leeds, this impressive detached family home offers a perfect blend of space, comfort, and modern living. Spanning an expansive 1,438 square feet, the property boasts four well-proportioned bedrooms, including a master suite complete with a dressing area and an en-suite bathroom.

The home features two en-suites upstairs, ensuring ample facilities for family and guests alike, alongside a conveniently located downstairs w/c and a family bathroom. The layout is thoughtfully designed providing versatile spaces for relaxation and entertainment.

The heart of the home is undoubtedly the kitchen/dining room, where double doors open out to a beautiful and well established rear garden. This outdoor space is a true highlight, offering various seating areas surrounded by tall trees and lush bushes, creating a serene retreat for family gatherings or summer evenings.

For those with vehicles, the property includes off-street parking for multiple cars, a detached garage, and additional outbuildings for storage, ensuring practicality alongside comfort.

This delightful home is perfect for families seeking a peaceful yet convenient location, with the charm of South Milford and easy access to local amenities. With its generous living spaces and stunning garden, this property is a rare find and a wonderful opportunity for anyone looking to settle in this desirable area.

VIEWING IS ESSENTIAL TO FULLY APPRECIATE THE PROPERTY ON OFFER! CALL US ON 01977 681122 TO BOOK A VIEWING! 'WE OPEN UNTIL 5.30PM MONDAY TO FRIDAYS and until 1PM SATURDAYS!



FEDERATION
OF INDEPENDENT
AGENTS

GROUND FLOOR ACCOMMODATION

ENTRANCE

Enter through uPVC double glazed sliding patio door from the front garden and this leads into;

ENTRANCE HALLWAY

23'9" x 6'11" (7.24 x 2.12)



Stairs which lead up to the first floor accommodation, a central heating radiator, original wooden beams to the ceiling and internal wooden doors which lead into;

KITCHEN/DINING

19'7" x 11'8" (5.99 x 3.58)



A double glazed window to the rear elevation, wooden shaker-style wall and base units surrounding, built in double oven, a four ring electric hob with a built in extractor fan over, one and a half white drainer sink with chrome taps over, space for a freestanding fridge/freezer, a stone built feature fireplace with a slate hearth and a wooden beam above, original wooden beams to the ceiling, a central heating radiator, a white vertical radiator, LED spotlights to the

ceiling, a uPVC door with a double glazed glass panel within which leads out to the side of the property and a double glazed double door which leads out to the rear garden.



LOUNGE

18'3" x 11'10" (5.57 x 3.63)



Two double glazed windows to the rear elevation, a cast iron fire set within a fireplace with a stone hearth and a wooden beam above, two central heating radiators and original wooden beams to the ceiling.



DOWNSTAIRS W/C

6'11" x 2'6" (2.11 x 0.77)

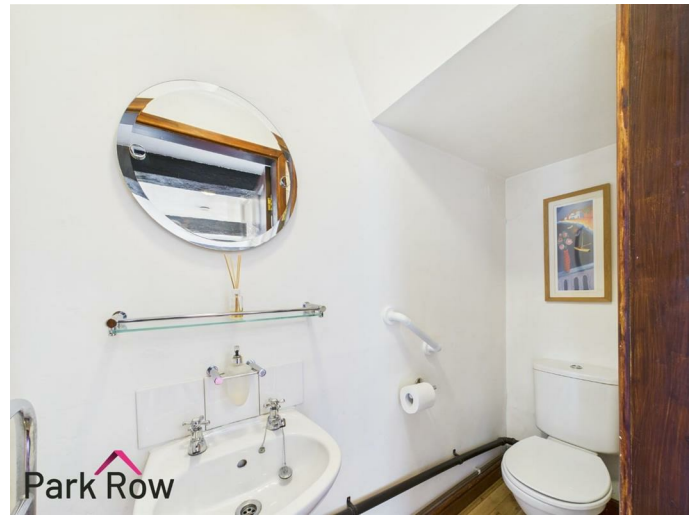

A close coupled w/c, a pedestal hand basin with chrome taps over and tiled splashback, a chrome towel rail and wooden doors which open up into an under-stairs storage cupboard.

UTILITY ROOM

8'0" x 6'1" (2.45 x 1.86)

Accessed via a wooden door from the front garden and includes; power, lighting, space and plumbing for a washing machine, space for a dryer, a Belfast with taps over plus there is space for storage together with space to hang your washing.

FIRST FLOOR ACCOMMODATION

LANDING

17'0" x 7'1" (5.19 x 2.16)

A double glazed window to the front elevation, original wooden beams to the ceiling and wooden internal doors which lead into;

DRESSING AREA TO BEDROOM ONE

9'3" x 7'1" (2.82 x 2.16)



A double glazed window to the front elevation, a central heating radiator, space for a dressing table and chairs plus it continues through to;

BEDROOM ONE

13'8" x 6'7" (4.18 x 2.03)



A double glazed window to the rear elevation, a white vertical radiator and a wooden door which leads into;

ENSUITE

6'3" x 5'7" (1.91 x 1.71)

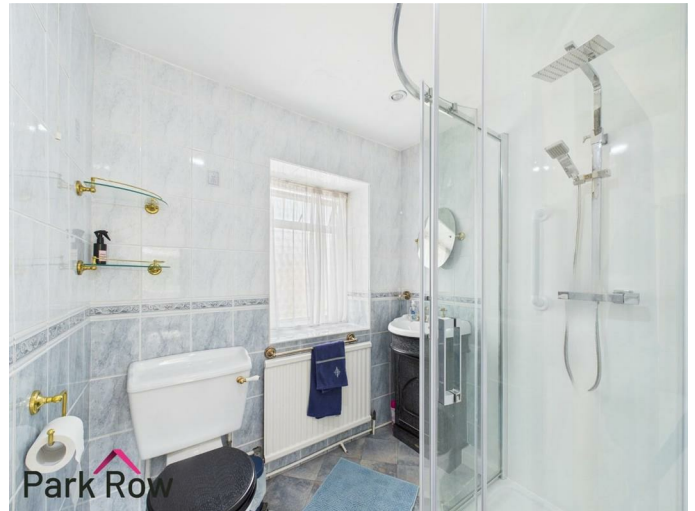

An obscure double glazed window to the front elevation and includes a white suite comprising; a close coupled w/c, a hand basin set within a black unit with space for storage, a corner mains shower with a glass shower screen, a central heating radiator, spotlights to the ceiling and is fully tiled floor to ceiling.

BEDROOM TWO

11'7" x 9'11" (3.54 x 3.03)



A double glazed window to the rear elevation with a built in window seat, a central heating radiator and an internal wooden door which leads into;

ENSUITE

8'3" x 2'6" (2.54 x 0.78)



Includes a white suite comprising; a close coupled w/c, a pedestal hand basin with taps over and tiled splashback, a walk in mains shower with a glass shower screen, spotlights to the ceiling and is fully tiled to the shower area.

BEDROOM THREE

12'0" x 9'4" (3.66 x 2.86)



A double glazed window to the rear elevation, a central heating radiator and an original wooden beam to the ceiling.



BEDROOM FOUR

12'0" x 6'4" (3.68 x 1.94)



A double glazed window to the rear elevation and a central heating radiator.

FAMILY BATHROOM

7'4" x 6'6" (2.26 x 2.00)



A double glazed obscure window to the front elevation and includes a white suite comprising; a close coupled w/c a pedestal hand basin with taps over, a corner panel bath with taps over, a central heating radiator and is half tiled to the wall around the bath.

EXTERIOR

FRONT



The substantial garden is accessed via the pathways at the side of the property or through the double doors in the kitchen/dining where you will step out onto; a paved pathway which runs the full width of the property, a paving stone pathway which leads through the garden, multiple spaces for outdoor seating, various mature trees and bushes creating a feel of privacy plus the rest is mainly the sizeable lawn.



FEDERATION
OF INDEPENDENT
AGENTS



FEDERATION
OF INDEPENDENT
AGENTS

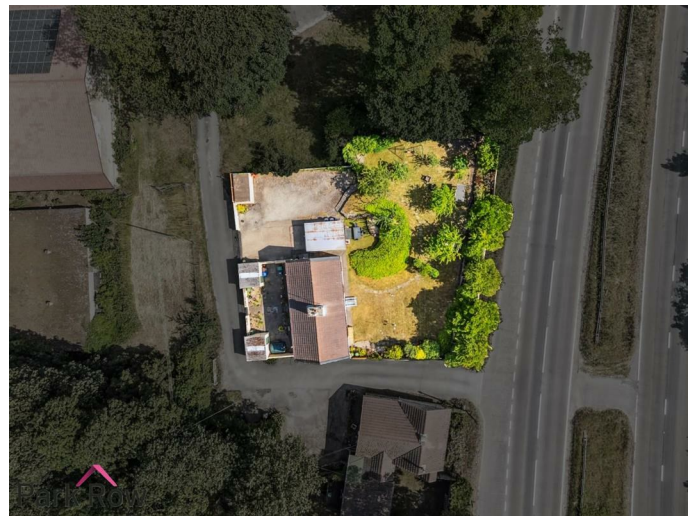

REAR



To the rear of the property there is a pedestrian gate which leads into the rear yard, a paved area with steps up that lead



FEDERATION
OF INDEPENDENT
AGENTS

into the hallway, two outbuildings with space for storage, space for outdoor seating and an open walkway which leads to the side of the property.



SIDE YARD

To the side of the property there is a vehicular access gate giving access, a concrete driveway with space for off street parking, access into the garage with space for storage, an area filled with decorative stones that could be used for further parking plus paved pathways which lead into the rear garden.

OUTBUILDINGS & GARAGE

The property has two outbuildings to the front garden and a garage at the side of the property which are all fantastic spaces for storage. (Measurements for all are on the floorplans)

TENURE AND COUNCIL TAX

Tenure: Freehold

Local Authority: North Yorkshire Council

Tax Banding: E

Please note: The Tenure, Local Authority and Tax Banding for the property have been advised by the Vendor or obtained from online sources. We strive to ensure these details are accurate and reliable, however, we advise any potential buyer to carry out their own enquiries before proceeding.

MAINS UTILITIES, BROADBAND, MOBILE COVERAGE

Electricity: Mains

Heating: Oil

Sewerage: Septic tank

Water: Mains/Metered

Broadband: Fibre (FTTP)

Mobile: 4/5G

Please note: The Utilities, Broadband and Mobile Coverage for the property have been advised by the Vendor or obtained from online sources. We strive to ensure these details are accurate and reliable, however, we advise any potential buyer to carry out their own enquiries before proceeding.

HEATING AND APPLIANCES

The heating system and any appliances (including Burglar Alarms where fitted) mentioned in this brochure have not been tested by Park Row Properties. If you are interested in purchasing the property we advise that you have all services and appliances tested before entering a legal commitment to purchase.

MAKING AN OFFER

In order to comply with the Estate Agents (Undesirable Practises) Order 1991, Park Row Properties are required to verify "the status of any prospective purchaser... This includes the financial standing of that purchaser and his ability to exchange contracts". To allow us to comply with this order and before recommending acceptance of any offers, and subsequently making the property 'SOLD' each prospective purchaser will be required to demonstrate to 'Park Row Properties' that they are financially able to proceed with the purchase of the property.

We provide truly Independent Mortgage Advice. Unlike many companies we are not tied, and more importantly not targeted to any Lender. We have instant on-line access to over 1000 mortgage deals provided by over 100 Lenders ensuring we are unbeatable when identifying and recommending your new mortgage or re-mortgage requirements.

Your home is at risk if you do not keep up repayments on a mortgage or other loan secured on it. Written quotations available on request. Life assurance is usually required.

To arrange a no obligation appointment please contact your local office.

MEASUREMENTS

These approximate room sizes are only intended as general guidance. You must verify the dimensions carefully before ordering carpets or any built-in furniture.

OPENING HOURS

CALLS ANSWERED :



FEDERATION
OF INDEPENDENT
AGENTS

Mon, Tues, Weds, Thurs and Fri - 9.00am to 5.30pm
Saturday - 9.00am to 1.00pm
Sunday - Closed

TO CHECK OFFICE OPENING HOURS PLEASE CONTACT THE
RELEVANT BRANCHES ON:

SELBY - 01757 241124
SHERBURN IN ELMET - 01977 681122
GOOLE - 01405 761199
PONTEFRACT - 01977 791133
CASTLEFORD - 01977 558480

VIEWINGS

Strictly by appointment with the sole agents.

If there is any point of particular importance to you we will be pleased to provide additional information or to make any further enquiries. We will also confirm that the property remains available. This is particularly important if you are travelling some distance to view the property.



FEDERATION
OF INDEPENDENT
AGENTS

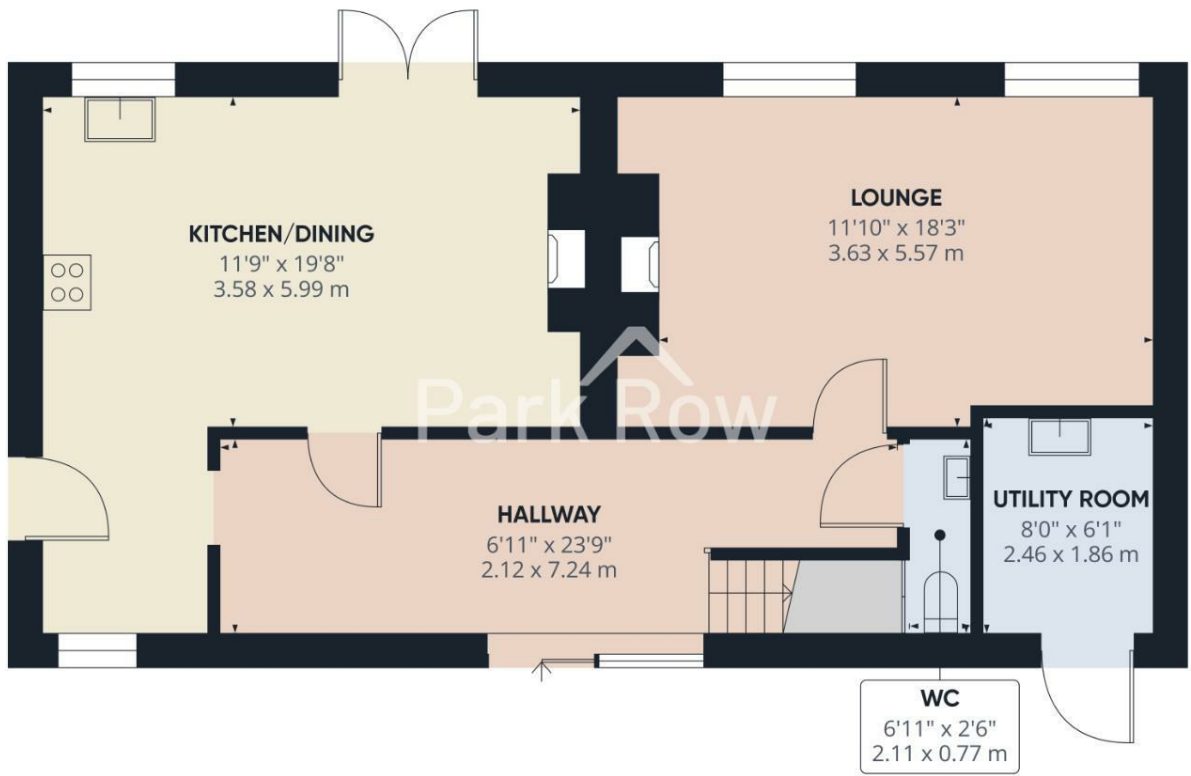

Approximate total area⁽¹⁾
735 ft²
68.2 m²

(1) Excluding balconies and terraces

Calculations reference the RICS IPMS 3C standard. Measurements are approximate and not to scale. This floor plan is intended for illustration only.

GIRAFFE360

Floor 0 Building 1



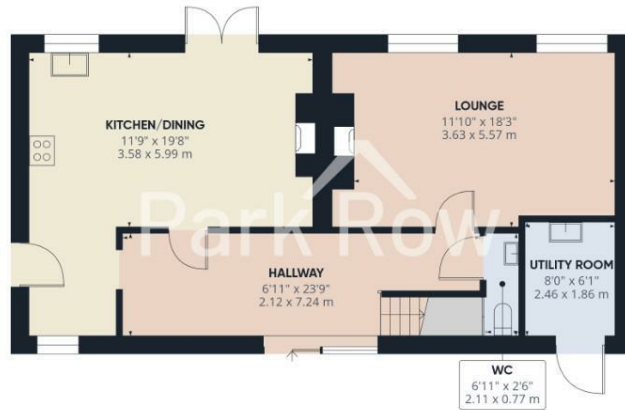

Floor 0 Building 1

Approximate total area⁽¹⁾
1438 ft²
133.5 m²



Floor 2 Building 1

(1) Excluding balconies and terraces

Calculations reference the RICS IPMS 3C standard. Measurements are approximate and not to scale. This floor plan is intended for illustration only.

GIRAFFE360

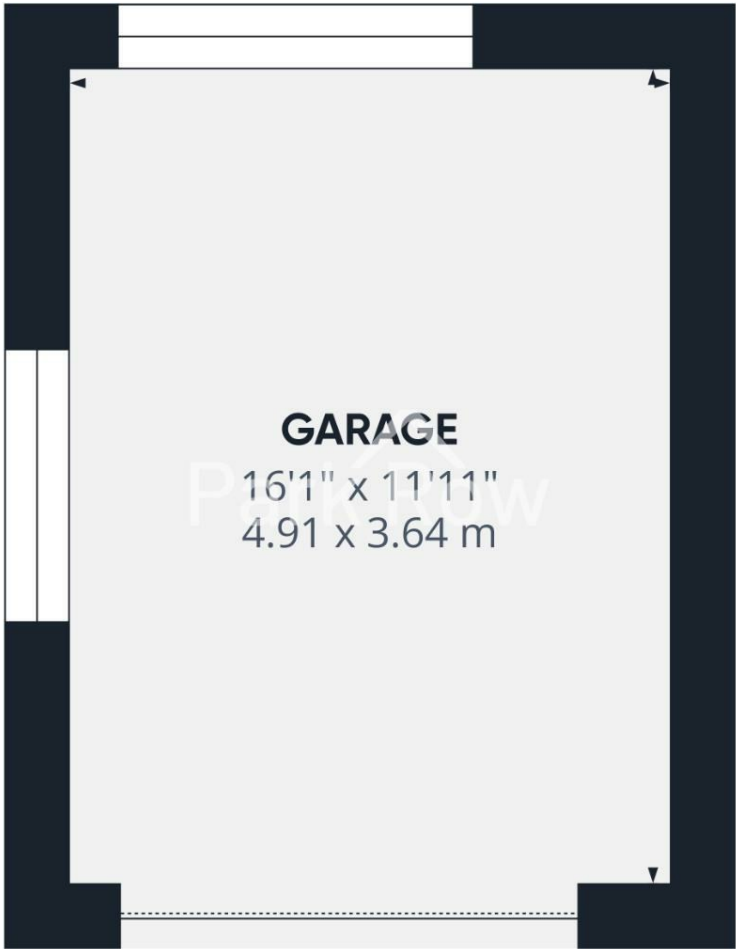

Floor 0 Building 4.

Approximate total area⁽¹⁾
194 ft²
18 m²

(1) Excluding balconies and terraces

Calculations reference the RICS IPMS 3C standard. Measurements are approximate and not to scale. This floor plan is intended for illustration only.

GIRAFFE360

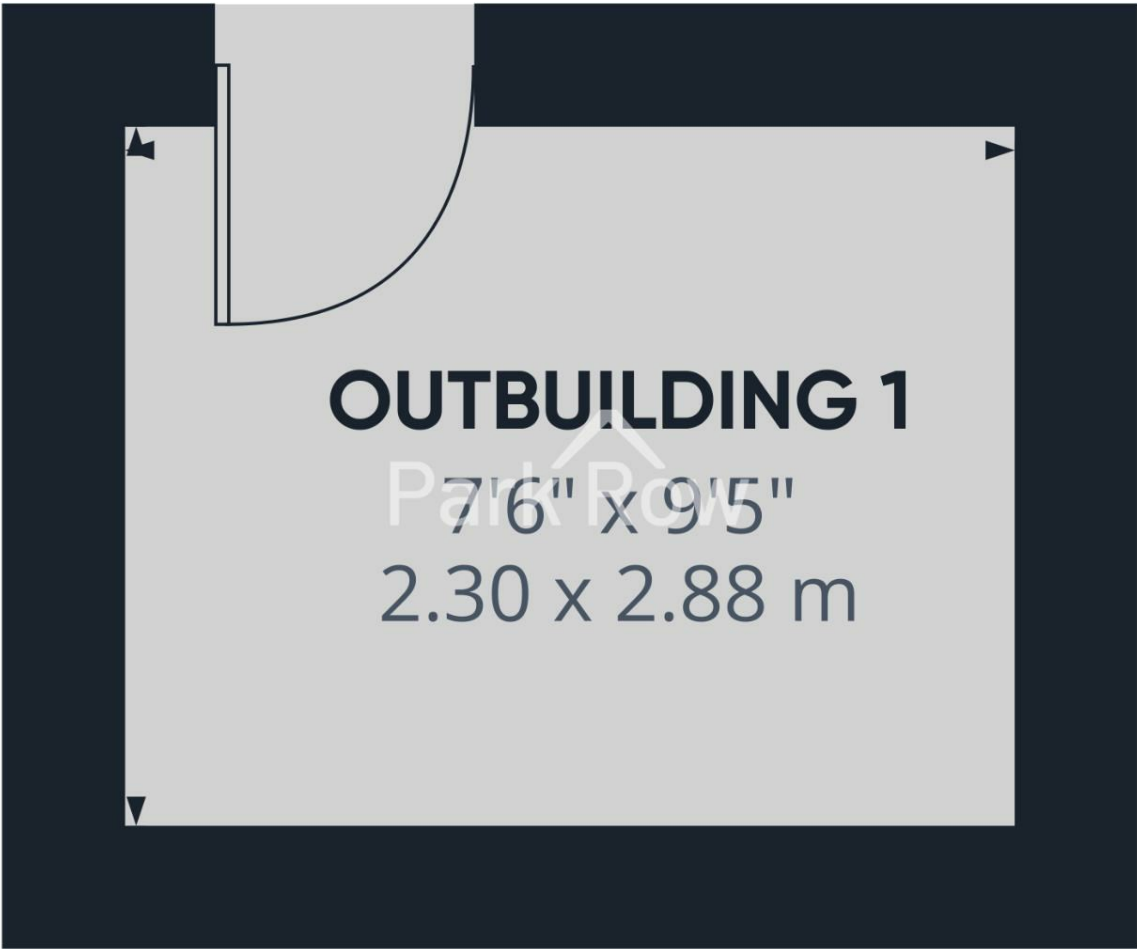

Approximate total area⁽¹⁾
71 ft²
6.6 m²

(1) Excluding balconies and terraces

Calculations reference the RICS IPMS 3C standard. Measurements are approximate and not to scale. This floor plan is intended for illustration only.

GIRAFFE360

Floor 0 Building 2



OUTBUILDING 2
7'4" x 9'3"
2.25 x 2.84 m

Floor 0 Building 3

Park Row

Approximate total area⁽¹⁾
69 ft²
6.4 m²

(1) Excluding balconies and terraces

Calculations reference the RICS IPMS 3C standard. Measurements are approximate and not to scale. This floor plan is intended for illustration only.

GIRAFFE360

T 01977 681122
W www.parkrow.co.uk

34 Low Street, Sherburn In Elmet, North Yorkshire, LS25 6BA
sherburn@parkrow.co.uk

Energy Efficiency Rating			Environmental Impact (CO ₂) Rating		
Score	Current	Potential	Score	Current	Potential
92-100			92-100		
81-91			81-91		
69-80			69-80		
55-68			55-68		
39-54			39-54		
21-38			21-38		
1-20			1-20		
Not energy efficient - higher running costs			Not environmentally friendly - higher CO ₂ emissions		
England & Wales	EU Directive 2002/91/EC		England & Wales	EU Directive 2002/91/EC	

Energy Efficiency Rating: 72 (Potential), 53 (Current)
Environmental Impact (CO₂) Rating: 66 (Potential), 48 (Current)