



Springlands | Frylands Lane, Wineham | Henfield | West Sussex | BN5 9BP

**H.J. BURT**  
Chartered Surveyors : Estate Agents







Springlands | Frylands Lane, Wineham | Henfield | West Sussex | BN5 9BP

Guide Price for whole: £2.65 million | Lot 1: Excess £2.25million



- Elegant and beautifully situated country house with picturesque lakes and delightful gardens, grounds, pastureland and woodland extending overall to approximately 25.70 acres (10.40Ha). **Available for sale as a whole or in up to 3 lots:**
- **LOT 1:** The delightful Grade II Listed country house including reception hall, sitting/dining room, snug/family room, gym/reception room, superb family kitchen/dining/sitting room, utility & laundry rooms, cloaks & boot rooms. Excellent South facing principal bedroom suite, 4 further bedrooms (3 with washing facilities & scope for additional en-suites), family bathroom. Attic bedroom 5 & adjoining room with potential.
- Beautiful mature gardens including cabin & office, swimming pool & outdoor recreation & relaxation areas incl. BBQ, dining, poolside bar & hot tub area. Planning consent for garage with 1<sup>st</sup> fl. office.
- Planning permission for 6 stables, tack & feed rooms, wash-down area, plus manege (40m x 20m).
- Adjoining pasture land and mature broadleaf bluebell woodland. Lot 1 extends overall to c. 11.43 ac. (4.63Ha).
- **LOT 2:** Adjoining pasture land and beautiful lake along with consent for 12m x 8m agricultural barn and new entrance. Extending to c. 6.5 ac. (2.63Ha).
- **LOT 3:** Fine gently sloping and South facing pasture field extending to c. 7.77 ac. (3.14Ha).

### Description

Springlands comprises an enchanting Grade II Listed country house with its own picturesque lakes and secluded glorious grounds: truly a rural idyll. With beautiful views over its gardens and lakes towards the distinctive ridge of the South Downs on the horizon, the house is also ideally positioned for excellent local amenities and convenient commuting from Haywards Heath, Burgess Hill or Hassocks stations. Springlands is within convenient driving distance of the popular and busy villages of Henfield and Hurstpierpoint (c. 4 miles & c. 4.5 miles respectively), and almost equidistant between Gatwick airport and the vibrant coastal city of Brighton and Hove. Hidden from the road, the house is approached through a pair of wrought iron gates mounted on brick pillars which open to a long driveway leading up to the house and passing the land.

Dating from the 16th and 19th centuries, the property combines fabulous historic character and charm with modern conveniences and luxurious additions. Period features include inglenook fireplaces, a number of exposed timbers, two priest holes, a flagstone floor in the reception hall and beautiful oak panelling in the sitting room. The house offers generous family accommodation, with particularly large room sizes and unusually high ceiling heights and natural light for a house of this age.

Springlands is a versatile home that combines cosy and comfortable family life with a capacity to host entertaining on a grand scale. There is also excellent potential (subject to all consents) to convert two of the four large attics into a further en-suite bathroom and a sixth bedroom or childrens den. The floorplan gives a comprehensive overview of the full extent of the accommodation and its layout, but there are a number of points worthy of particular note.

The studded oak front door opens to an **impressive part-panelled reception hall** with a working inglenook fireplace. There are a further **three characterful reception rooms** including panelled sitting room with parquet floor and a second working **inglenook fireplace as its focal point**, a separate cosy family room and a versatile gym.

The **superbly appointed kitchen, dining and family room forms the hub of the home** and is fitted with a range of **bespoke cabinetry and a central island**, with granite worktops, integrated appliances and a Rangemaster oven. There is ample space for a large dining table and sofas, and a square bay set with French doors at the Southern end of the room **perfectly frames the views of the gardens and lakes to the South Downs** in the distance. A cloakroom, boot room, utility room and laundry room complete the ground floor.

There are **five large double bedrooms arranged over the first and second floors**, including a **generous principal suite with a large en-suite bathroom and wonderful views**. Three of the remaining bedrooms have their own vanity units with wash basins and the fifth bedroom has an opportunity to create its own en-suite bathroom (subject to consents). The principle en-suite bathroom is large enough to accommodate a fourth bathroom if so desired and as well as the potential for en-suites to be created to other bedrooms.

The gardens and grounds to Lot 1 are of particular note and together with adjacent pasture land and woodland extend overall to approximately 11.43 acres (4.63Ha).























These grounds are established and well-stocked with a number of mature specimen trees offering a high degree of privacy, and a haven for a huge variety of wildlife. The house sits almost centrally within the grounds, overlooking the tree-lined lakes, which extend away from the house to the South. The gardens closer to the house are informally divided into various areas and include an expanse of lawn lying to the East dotted with fruit trees (the 'sports garden') and an excellent enclosed 'leisure garden' with swimming pool, hot tub, two cabins, poolside bar and terraces: ideal for summer entertaining and al-fresco dining.

The pasture land lies to the East and North of the house and also bordering the further land forming part of Lot 2 to the South. There are three picturesque ponds forming part of Lot 1 and an area of glorious deciduous woodland extending to the North with a magnificent display of bluebells in the spring. Lot 1 also includes planning permission (ref. DC/21/151 granted 12th May 2022) for equestrian facilities including six stables, tack and feed rooms, hay barn, wash-down area and manege (40m x20m). In addition, there is planning consent (ref. DC/21/0820 granted on 8th September 2021) for a detached garage with home office over.

**Lot 2** extends to c. 6.5 acres (2.63 Ha) and includes a large pasture field to the South of Lot 1 and with access from the shared entrance drive as well as planning consent for a new access to the South and which in turn would serve a proposed agricultural barn as granted under planning consent SC/21/1550 on 28th January 2022. Lot 2 also includes the largest lake providing wonderful recreational opportunities as well as being a haven for wild and birdlife.

**Lot 3** extending to c. 7.7 acres (3.14 Ha) lies to the West of the entrance drive with gated access therefrom and comprises a gently sloping South facing agricultural field also enjoying a fine rural outlook.

### Location

Springlands is situated in a wonderful rural location, in the popular hamlet of Wineham, home to the famous Royal Oak pub. Conveniently located, Wineham sits between Brighton and Gatwick, between the A23 and the A24 and between the vibrant villages of Henfield and Hurstpierpoint.







**Local amenities:** Henfield and Hurstpierpoint include a range of local shops, boutiques, cafes, restaurants, pubs, post offices, village halls, libraries, health centres and leisure centres. More extensive shopping and recreational facilities can be found in Haywards Heath, Burgess Hill, Horsham and Brighton & Hove.

For equestrian enthusiasts, Hickstead is within riding distance of the property and Hascombe Farm Equestrian Centre is a short drive away. It is also well located for horse racing and polo at Plumpton, Lingfield, Goodwood, Knepp Castle and Cowdray Park. There are many miles of beautiful walks and rides over the surrounding countryside including at least seven walks directly from the property and more on the nearby South Downs National Park. The area is well served for the arts, with theatres and galleries in Brighton and opera at Glyndebourne. There are many well-known golf courses close-by, such as Singing Hills, Mannings Heath, Mid Sussex and Pyecombe; plus further sporting opportunities at Wickwoods Country Club and Brighton Marina.

**Transport:** Fast and regular rail services to Brighton, London Bridge and London Victoria run from Hassocks, (6 miles journey time from 56 minutes trains), Burgess Hill (7 miles, from 54 mins) and Haywards Heath (8 miles, from 42 mins). Gatwick Airport is about 18 miles by road and has a fast rail service, the Gatwick Express, to London (journey time 30 mins).

**Schools:** there is a good selection of state and private schools in the area, including Brighton College, Hurstpierpoint College, Lancing College, Steyning Grammar and Burgess Hill Girls.

### Information

**Property Reference:** 543623. Photos (2022/3) & particulars (April 2024) ref RBA.

**Services:** Mains electricity and water are connected to Lot 1 with private drainage system, oil-fired central heating and LPG for cooker.

**Local Authority:** Horsham District Council. **Council Tax Band:** 'H'.

**Freehold title:** WSX339979.

**The Vendors reserve the right not to sell Lots 2 & 3 until such time as Lot 1 has been sold and they also reserve the right to sub-divide or combine lots.** If the property is sold in lots, appropriate cross-easements will be granted between lots for connections to mains services and supplies as well as any interconnected drainage and the stream/spring feed to the lakes. Details on the ownership and future maintenance of boundaries between lots will be included as part of the terms of sale and further details of which will be available from the Agents including regarding services, rights of way and general covenants.



## Directions

Heading West on the A272, pass under the A23 and past the village of Bolney and Bolney Chapel Road on the left-hand side and after about a mile take the next left into Wineham Lane. Continue for about two miles, passing The Royal Oak on the right-hand side and then turn right into Frylands Lane. The signposted driveway leading to Springlands (and the separately owned Springlands Barn) can be found after half a mile on the right-hand side.

## Viewing

Strictly by appointment with Vendors; joint sole selling agents Savills or:

### H.J. BURT Steyning

The Estate Offices | 53 High Street | Steyning | West Sussex | BN44 3RE

01903 879488 | [www.hjburt.co.uk](http://www.hjburt.co.uk) | [steyning@hjburt.co.uk](mailto:steyning@hjburt.co.uk)



**IMPORTANT NOTE:** These particulars and photographs were prepared on the date as stated above by H.J. Burt in good faith for the guidance of purchasers. The descriptions, measurements and distances within the particulars were taken by H.J. Burt or taken from information supplied by the vendor, but should only be relied upon as approximations and not as statements or representations of fact. Information regarding the tenure of this property has not been verified and purchasers should consult their own solicitor for verification. H.J. Burt offer no warranty as to the condition of the property, services or appliances. Purchasers should satisfy themselves as to such condition. H.J. Burt have not made any enquiry concerning Planning Consents, Building Regulations or other approvals for any part of the property unless specifically referred to and purchasers are advised to make their own enquiries of the Local Authority.













# Springlands, Fryland Lane, Wineham, Henfield

Main House internal area 4,367 sq ft (406 sq m)

Garage internal area 202 sq ft (19 sq m)

Pump Room & Changing Room, Pool Bar internal area 100 sq ft (9 sq m)

Cabin/Office, Pool House & Changing Room, Log/Wood Store internal area 497 sq ft (46 sq m)

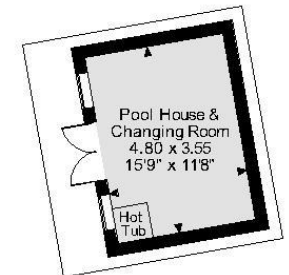
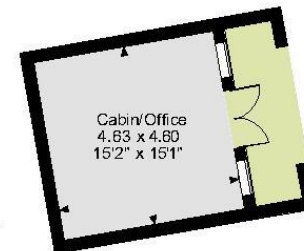
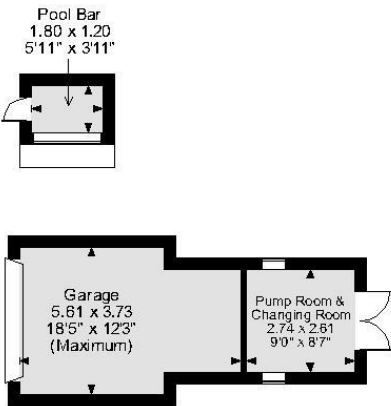
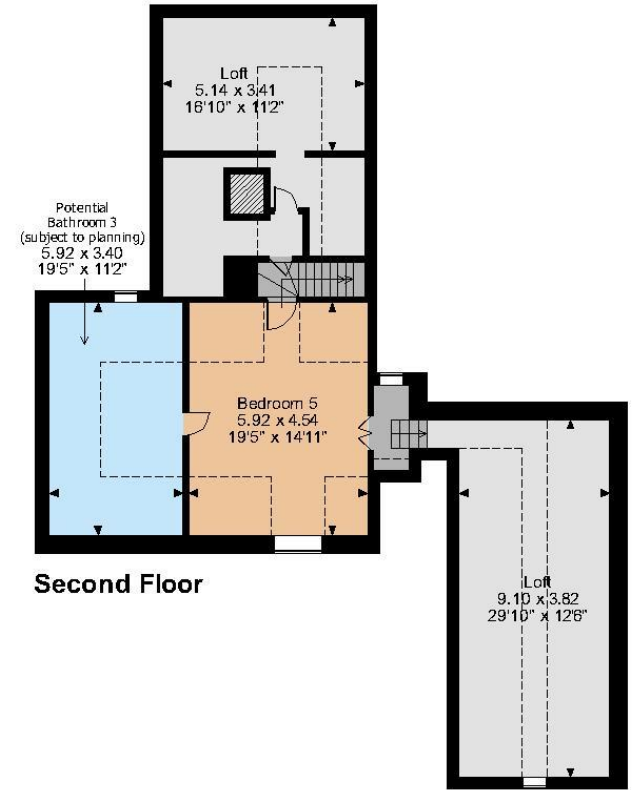
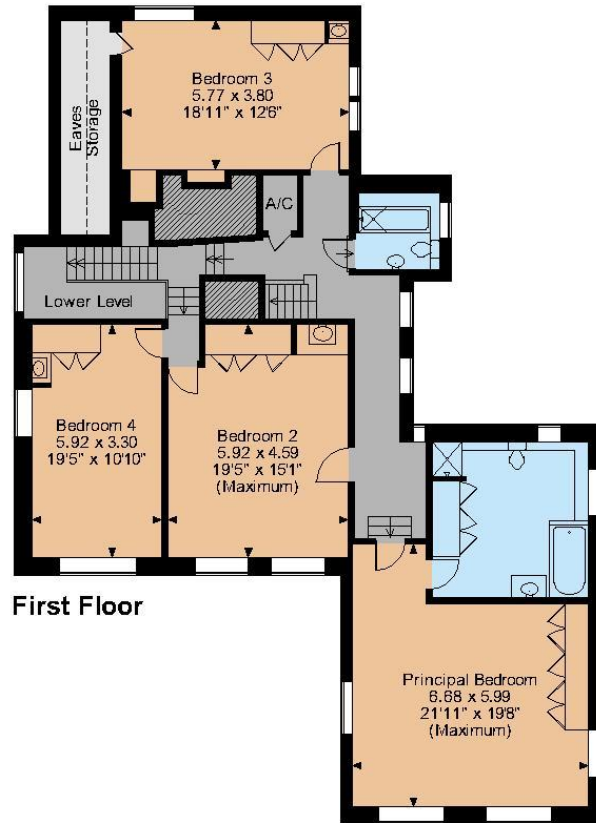
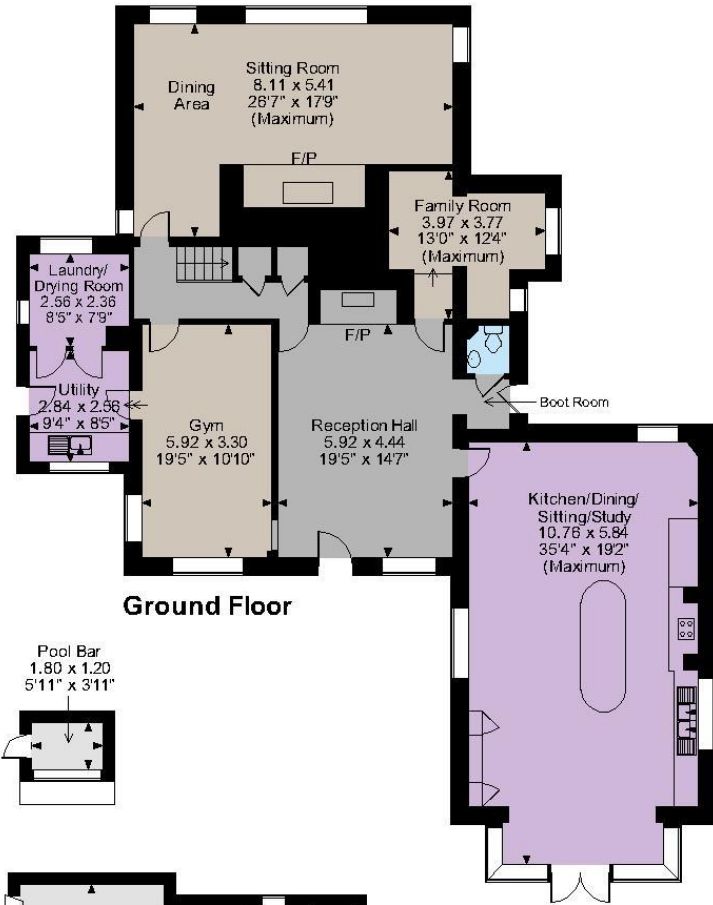
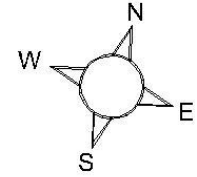

**FOR ILLUSTRATIVE PURPOSES ONLY - NOT TO SCALE**  
 The position & size of doors, windows, appliances and other features are approximate only.  
 □□□ Denotes restricted head height  
 © ehouse. Unauthorised reproduction prohibited. Drawing ref. dig/8500140/DWL











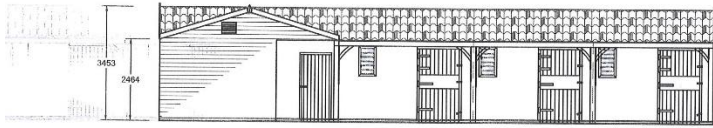

Front Elevations

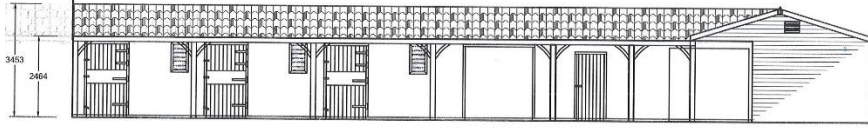

Rear Elevations

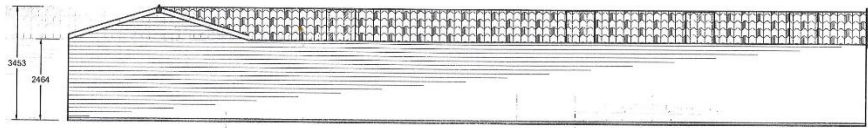
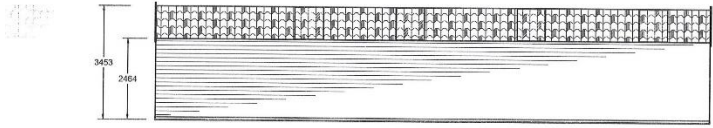

Consented stable block & manege

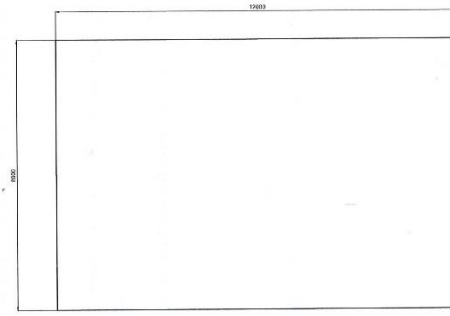

Consented agricultural barn

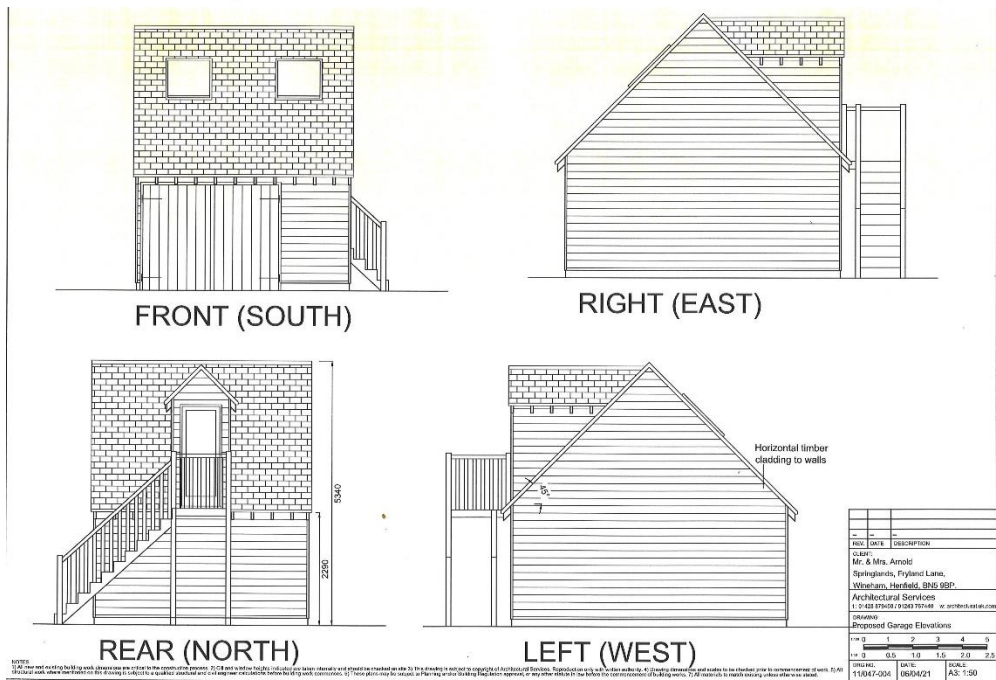
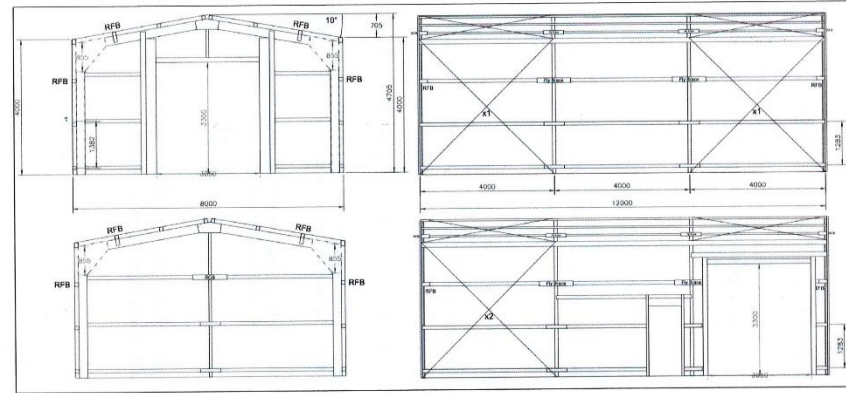

Consented garage with room over







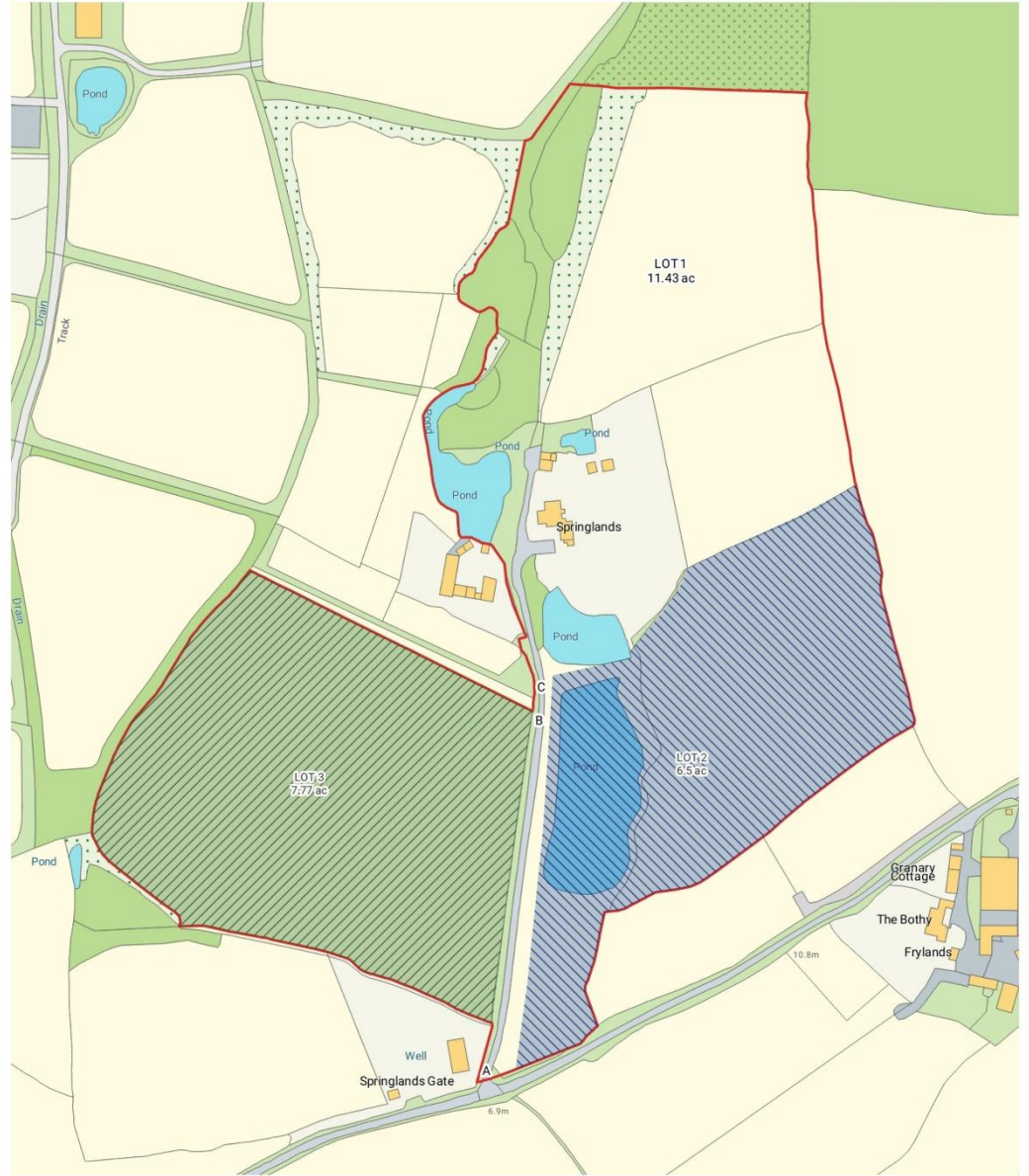
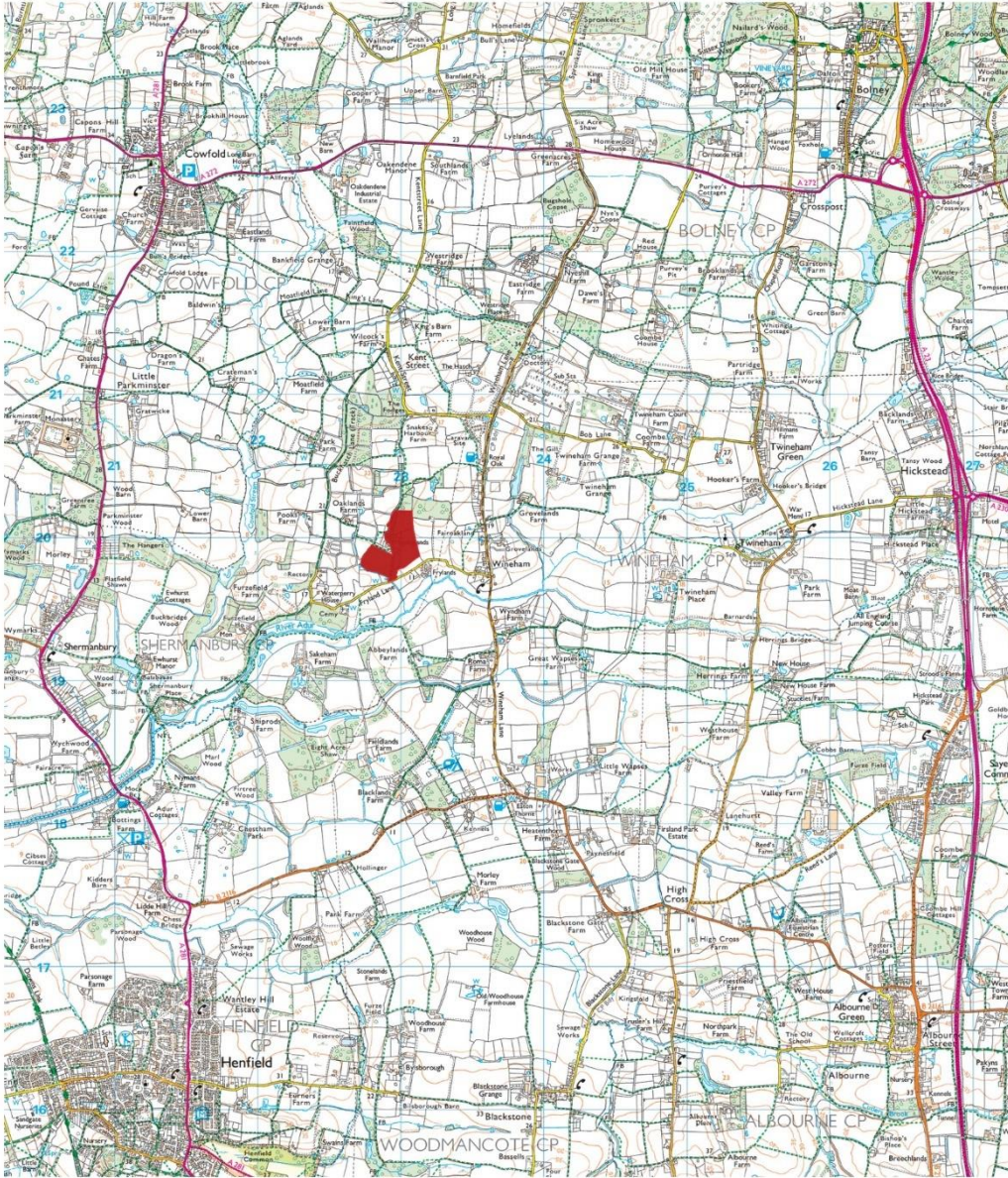





**H.J. BURT**  
Chartered Surveyors : Estate Agents

**rightmove**  
find your happy

UKLANDand  
FARMS.co.uk

**ZOOPLA**

**PrimeLocation.com**

01903 879488 | [www.hjburt.co.uk](http://www.hjburt.co.uk)

Part of the Local Community since 1887 | Offices at Steyning & Henfield | Town & Village Properties | Land | Country Properties | Lettings & Management | Equestrian | Commercial | Valuations | Professional Services