



Sandford Country Cottages, Fife, DD6



A unique collection of properties set within the grounds of a **magnificent B listed Arts and Crafts house** close to St. Andrews. Four/five bedroom main house, six luxury self catering units and two land plots with planning for future development.

Overview

This charming property was designed as 'Sandford Cottage' by renowned architect M H Baillie Scott for James Harben Valentine in 1901-2. Fully restored by the current owners and set within the delightful Fife countryside, this is a wonderful home in an ideal location, just 10 miles from St Andrews and 5 miles from Dundee. The property currently operates as a thriving 5-star holiday destination with six luxury self-catering units. The current owners have maintained, developed and operated the property with great care and attention over the years and have created a wonderful opportunity for the next ownership.

Accommodation

Sandford House, a B listed Arts and Crafts home with four to five bedrooms

Six luxury self catering properties, totalling fourteen letting bedrooms, all en suite

The Coach House

Valentines

Baillie Scott

The Giddy Limit

Lady Bluebell

Red Squirrel Apartment

Garaging | Workshop | Treehouse | BBQ house

Beautifully maintained and extensive mature gardens

Fully restored throughout, in keeping with the Arts and Crafts style, Sandford House is stunningly presented throughout. This is a unique opportunity for purchasers to acquire a magnificent B listed period property in the most unique of locations, with the ability to deliver strong operational returns going forward.



Location

Sandford House sits in an idyllic, private country setting close to the popular coastal villages of Newport on Tay and Wormit. It has outstanding views over the surrounding Fife countryside which include glimpses of the mighty River Tay to the north.

The property is highly accessible, well positioned for access to Dundee, Cupar and St. Andrews, with Perth, Aberdeen and Edinburgh also within comfortable driving distance. Good local services are available in Wormit and Newport on Tay, with all of Dundee's facilities and amenities on hand across the River Tay.

Cupar, Fife's bustling market town, lies a ten minutes' drive to the south and offers an excellent range of shops and services as well as a thriving monthly farmers' market. The ancient and historic town of St. Andrews, globally acclaimed as the Home of Golf, lies about ten miles to the south-east.

North-east Fife provides access to an area of particular outstanding and varied countryside with hill, wood, river, farmland and coastline. As a result there is a wide range of outdoor activities on hand with walking, cycling, watersports and riding all readily available. It is perhaps golf for which Fife is most well-known with numerous top-quality courses in a comparatively small area, including the world-renowned Old Course at St. Andrews which regularly hosts the Open Championship and Dunhill Cup. Other notable courses nearby include Carnoustie, Ladybank, Scotsraig, Kingsbarns, Dumbarnie, Blairgowrie, Downfield and Crail.

Shooting and fishing may be taken locally whilst the lovely quaint fishing villages of the East Neuk like Elie, Anstruther, Pittenweem and St. Monans are well within striking distance.

There are good state primary and secondary schools in the area with independent schooling on hand at a number of highly rated schools, including St. Leonards at St. Andrews and the High School of Dundee. There are railway stations in Leuchars, Cupar, Ladybank and Dundee with Edinburgh airport approximately one hour to the south. The regional airport at Dundee offers short-haul flights.

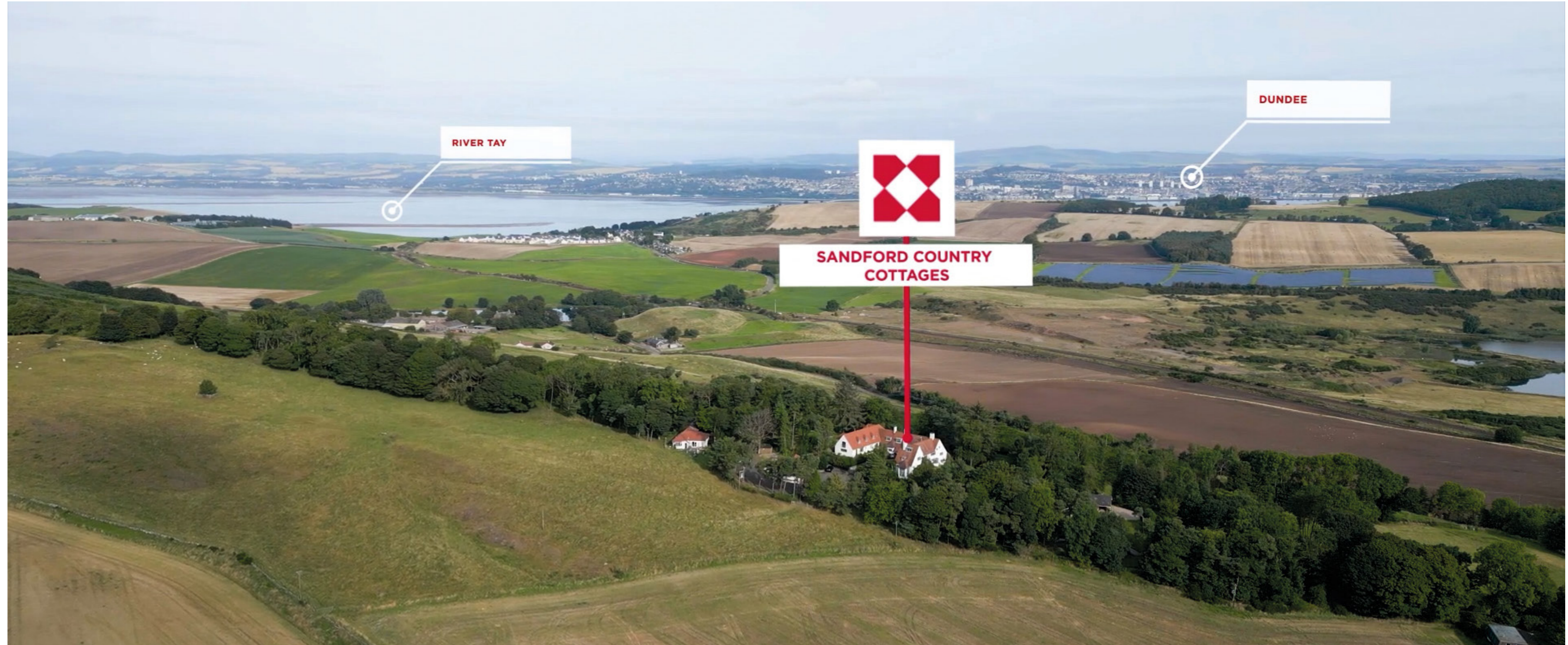

The Property & Operations

The self-catering cottages have been operational over the last decade after an extensive period of upgrading and redevelopment from the purchase of the property in 2010. The property renovations have all involved rewiring, re-plumbing and the installation of new septic tanks on the site. The detached Coach House cottage was constructed and begun trading in 2019.

The only other staff working at Sandford Cottages are two housekeepers who assist with changeovers. The business currently operates with three night minimum stays and is extremely popular with larger groups, either for family get togethers, as accommodation for local events, or golf tourers and visitors who use the cottages as a base to explore the surrounding areas.

The website domain would be available with the sale of the property:
<https://www.sandfordcountrycottages.co.uk/>

All furniture, fixtures and fittings required for the operation of the self-catering cottages would be included within the sale price. Personal items and furniture within Sandford House would be excluded from the price.

Gross incomes in excess of £225,000 per annum have been achieved by the current owners. Current and historic trading performance will be made available to serious parties on formally viewing the property. There is excellent potential along with current and future bookings to make a strong business out of Sandford Cottages and the potential to develop the offering in future years by adding further accommodation.

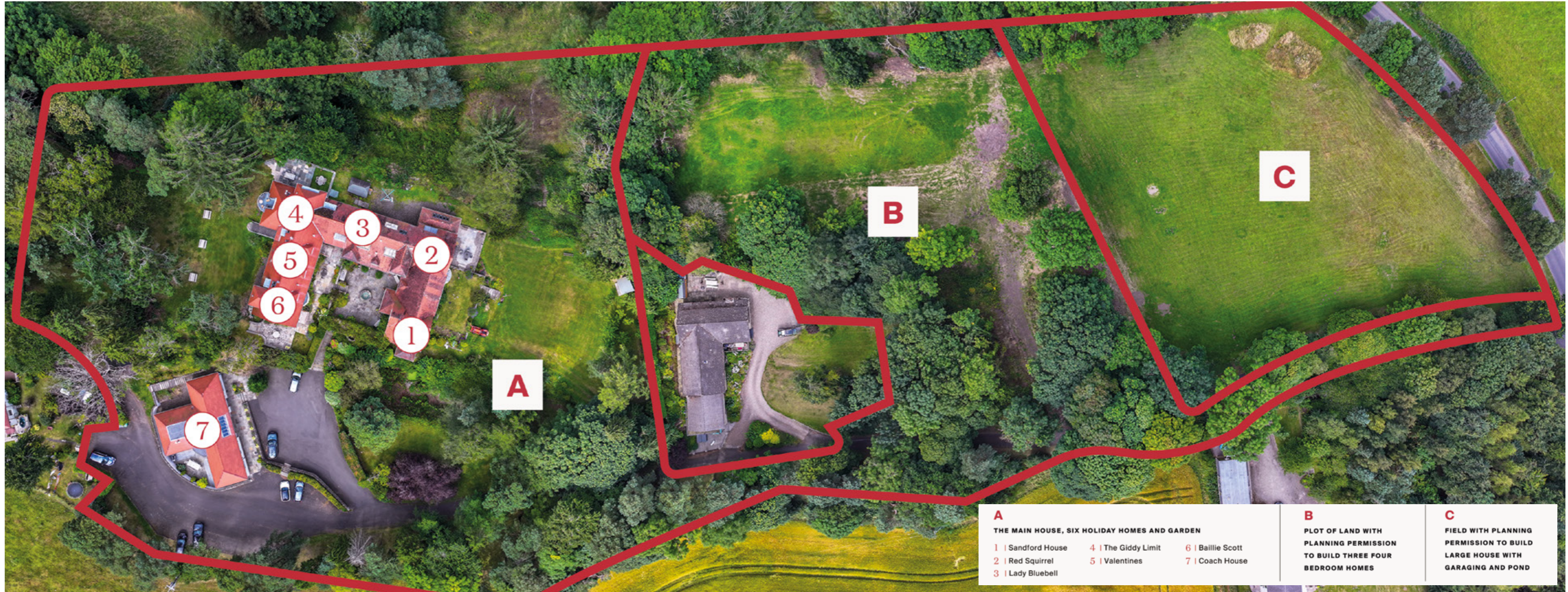

A	B	C
THE MAIN HOUSE, SIX HOLIDAY HOMES AND GARDEN	PLOT OF LAND WITH PLANNING PERMISSION TO BUILD THREE FOUR BEDROOM HOMES	FIELD WITH PLANNING PERMISSION TO BUILD LARGE HOUSE WITH GARAGING AND POND
1 Sandford House 2 Red Squirrel 3 Lady Bluebell	4 The Giddy Limit 5 Valentines 6 Baillie Scott 7 Coach House	



Sandford House

This beautiful home acts as the owners house. With plentiful entertaining space, it has an open plan kitchen dining area, family room and two further living rooms. The first floor offers two double bedrooms with a family bathroom and a generous principal suite with an en suite bathroom. A home office completes this level and lends itself nicely as another bedroom with some reconfiguration. The attic room on the second floor could be used as a further bedroom or family space.



4/5



2



3



Sandford House

Approximate Gross Internal Floor Area
 5,059 sq ft / 470 sq m
 Attic 376 sq ft / 35 sq m

This plan is for guidance only and must not be relied upon as a statement of fact. Attention is drawn to the Important Notice on the last page of the text of the Particulars.



- Reception
- Bedroom
- Bathroom
- Kitchen/Utility
- Storage
- Outside

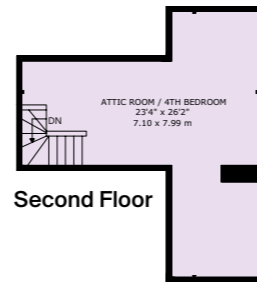

Second Floor

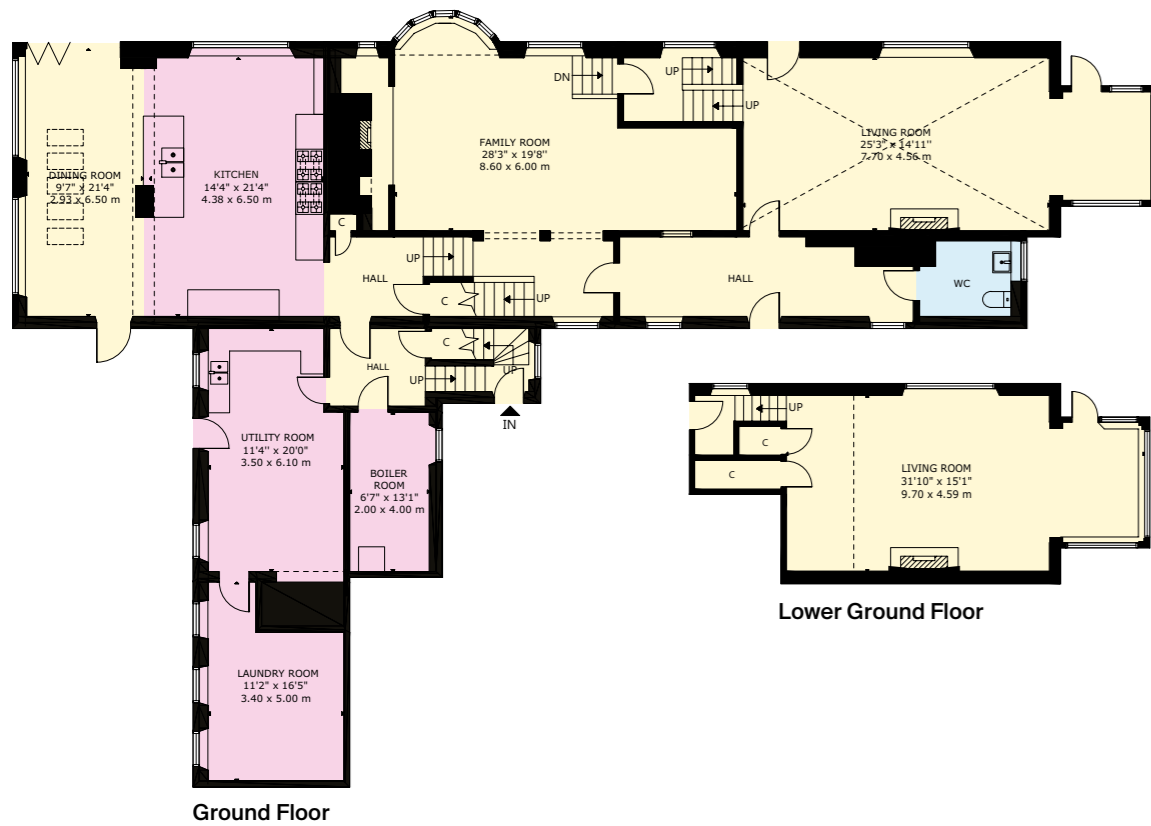

Lower Ground Floor

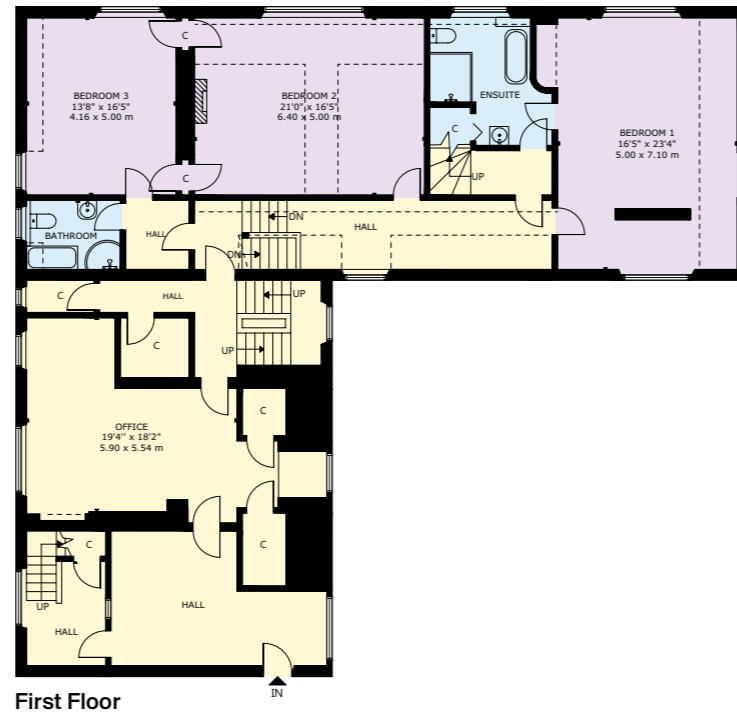

First Floor



Red Squirrel Apartment

A delightful one bedroom apartment located on the second floor of the original house, with open plan kitchen living space.



Approximate Gross Internal Floor Area
904 sq ft / 84 sq m

This plan is for guidance only and must not be relied upon as a statement of fact. Attention is drawn to the Important Notice on the last page of the text of the Particulars.

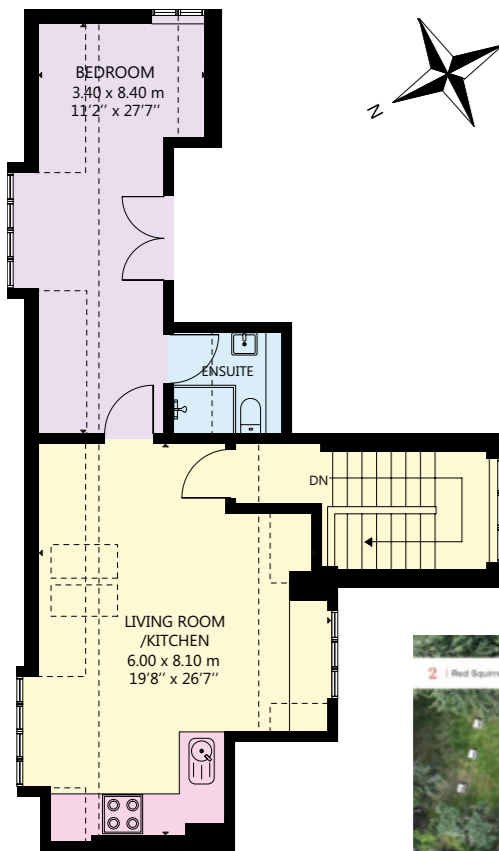

Lady Bluebell

A three bedroom apartment, all double bedrooms with en suite bedrooms and with its own private terrace leading to the garden. It is named after Lady Bluebell Walker who lived here along with her family from 1930 - 1960.



Valentines

Charming cottage with two double, en suite bedrooms and lovely open plan kitchen/living/ dining space. It is named after Harben J Valentine who commissioned Baillie Scott to design 'Sandford Cottage' as the house was known in 1902.



Lady Bluebell

Approximate Gross Internal Floor Area
1,227 sq ft / 114 sq m

This plan is for guidance only and must not be relied upon as a statement of fact. Attention is drawn to the Important Notice on the last page of the text of the Particulars.

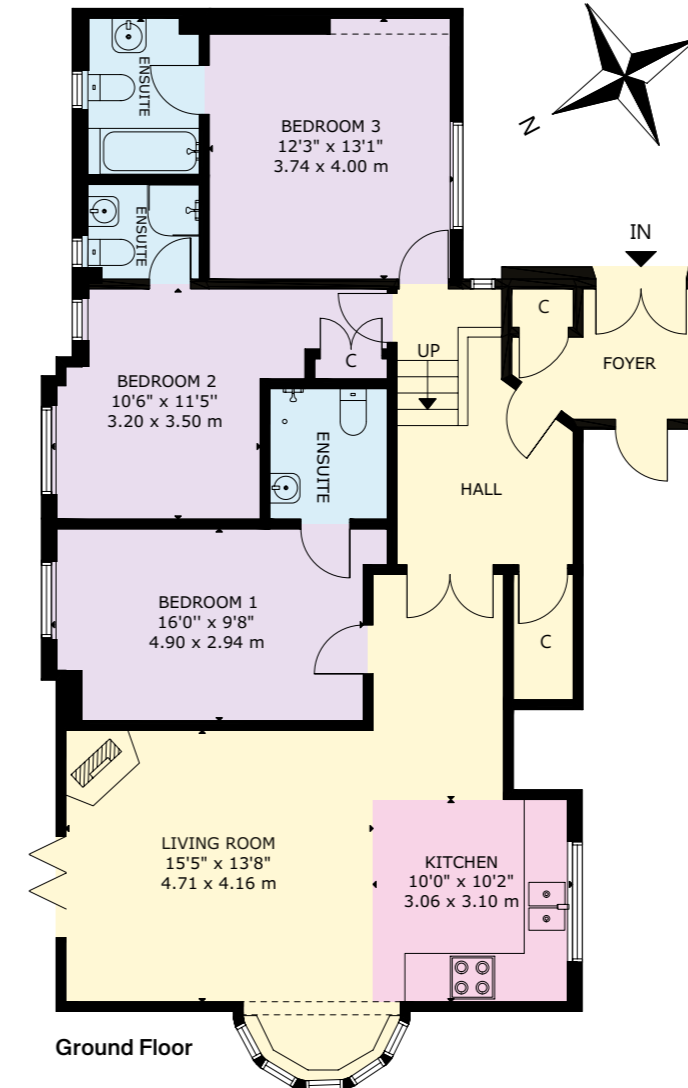

Valentines

Approximate Gross Internal Floor Area
656 sq ft / 61 sq m

This plan is for guidance only and must not be relied upon as a statement of fact. Attention is drawn to the Important Notice on the last page of the text of the Particulars.

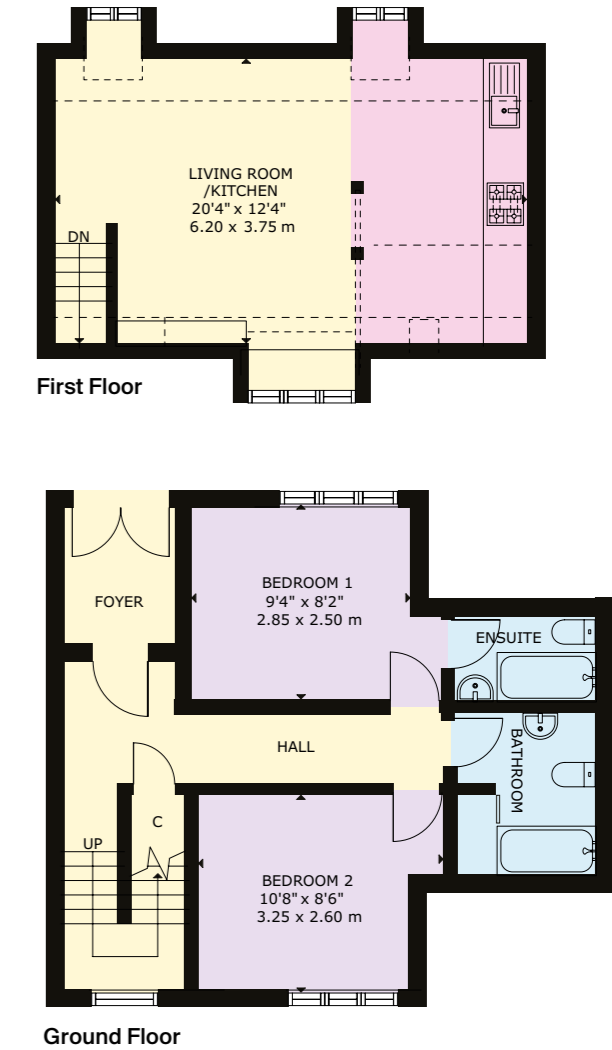

The Giddy Limit

A stunning three bedroom apartment, all double bedrooms with en suites bathrooms. The living space is the focal point of this apartment with it's open plan kitchen, living area, woodburning stove and external balcony area.



Approximate Gross Internal Floor Area
 1,292 sq ft / 120 sq m
 Balcony 114 sq ft / 11 sq m

This plan is for guidance only and must not be relied upon as a statement of fact. Attention is drawn to the Important Notice on the last page of the text of the Particulars.

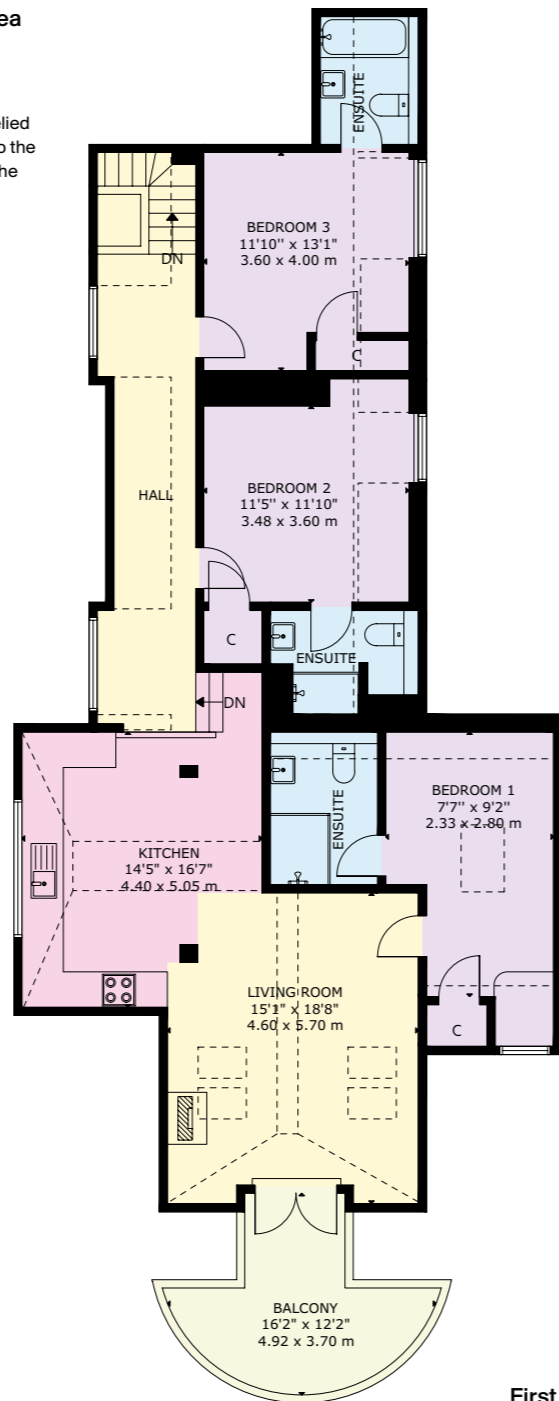

First Floor



Baillie Scott

A two bedroomed cottage which sleeps four in two en suite bedrooms. It has a bright, open plan kitchen/living/dining space. It is named after the architect Mackay Hugh Baillie Scott who designed Sandford back in 1902.



Approximate Gross Internal Floor Area
1,119 sq ft / 104 sq m

This plan is for guidance only and must not be relied upon as a statement of fact. Attention is drawn to the Important Notice on the last page of the text of the Particulars.

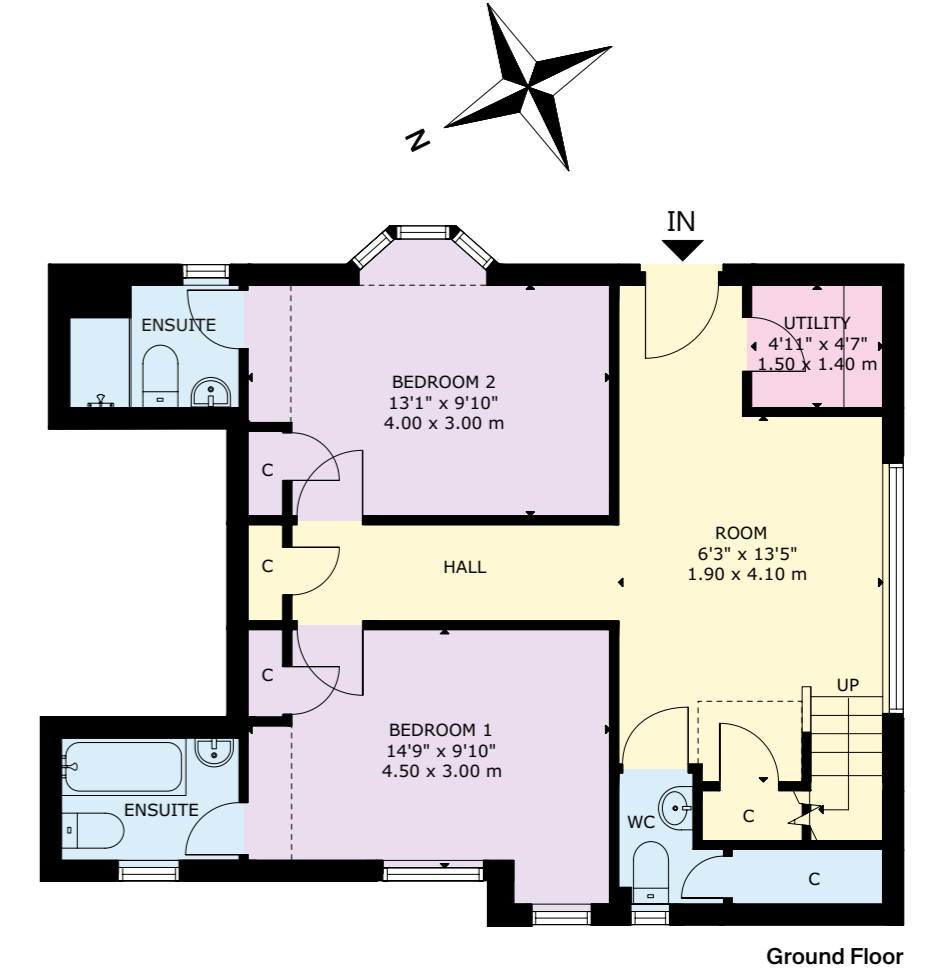
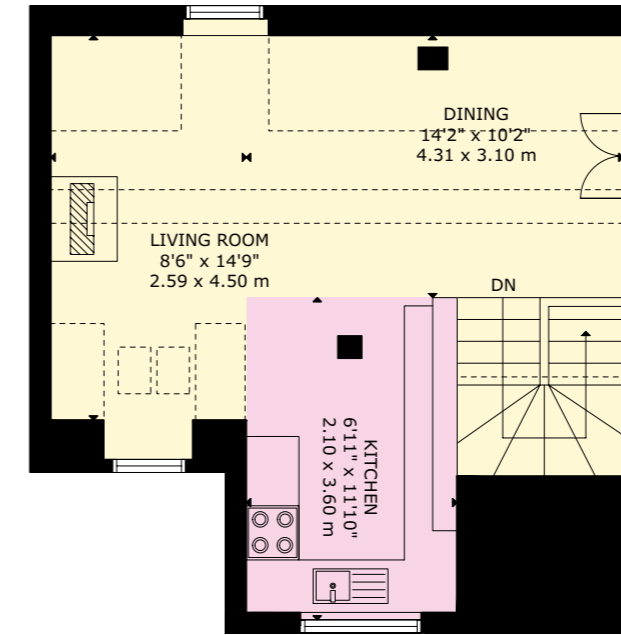

The Coach House

A new detached cottage which is wheelchair accessible. It is very spacious property with three large en suite bedrooms, one of which has a large walk-in wet room.



Approximate Gross Internal Floor Area
1,630 sq ft / 151 sq m

This plan is for guidance only and must not be relied upon as a statement of fact. Attention is drawn to the Important Notice on the last page of the text of the Particulars.

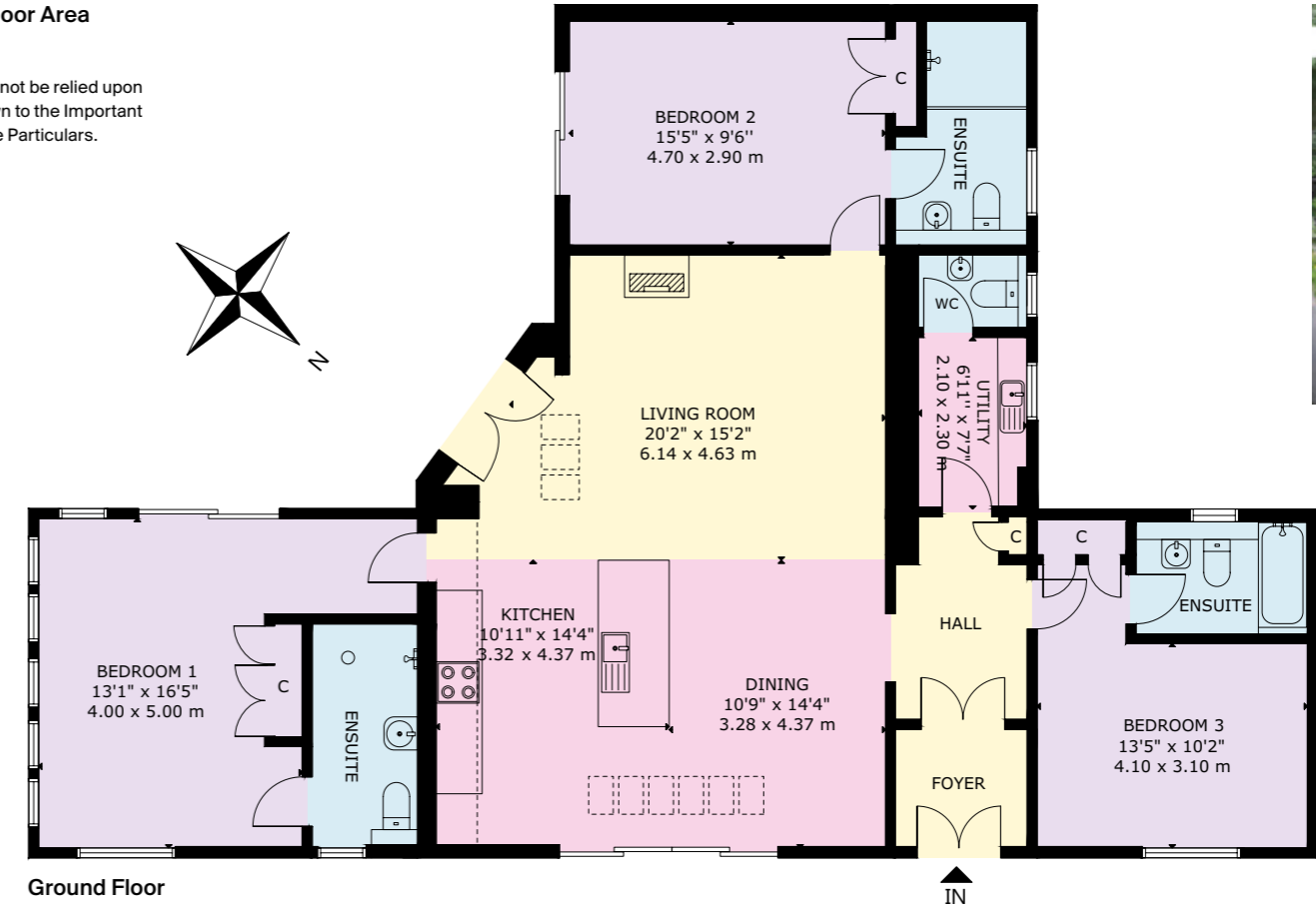

The Outhouses

Approximate Gross Internal Floor Area

- BBQ Hut: 246 sq ft / 24 sq m
- Workshop: 844 sq ft / 80 sq m
- Garage: 636 sq ft / 60 sq m
- Treehouse: 451 sq ft / 42 sq m
- Deck: 97 sq ft / 9 sq m

This plan is for guidance only and must not be relied upon as a statement of fact. Attention is drawn to the Important Notice on the last page of the text of the Particulars.

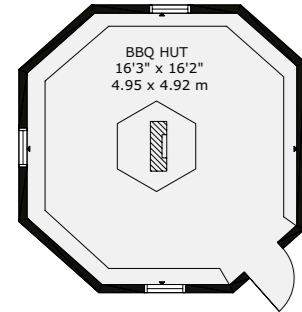

BBQ Hut

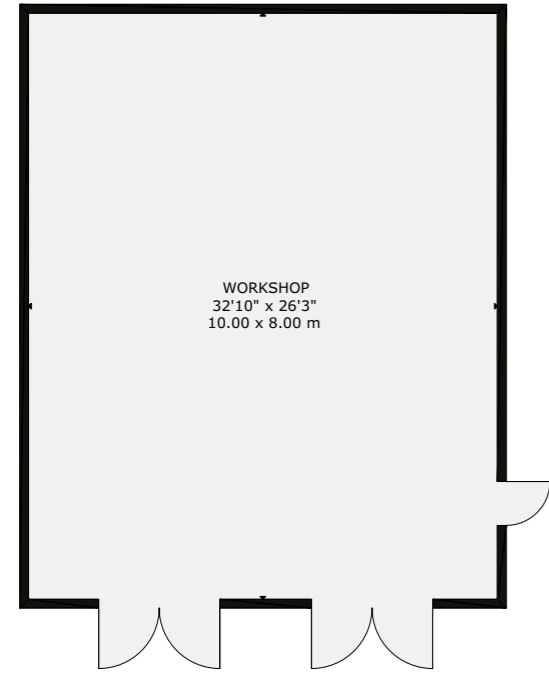

Workshop

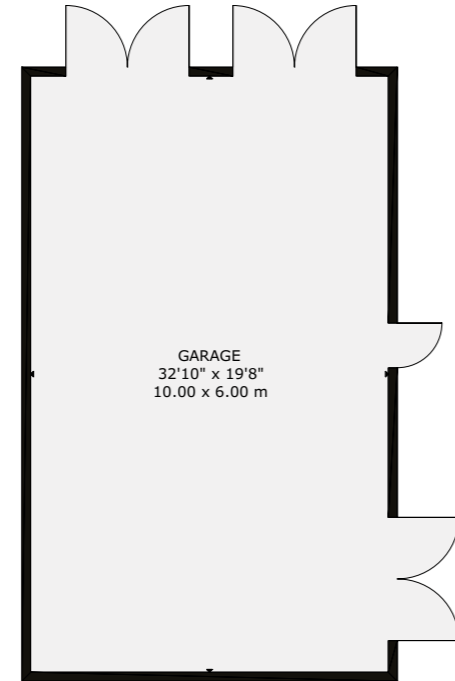

Garage

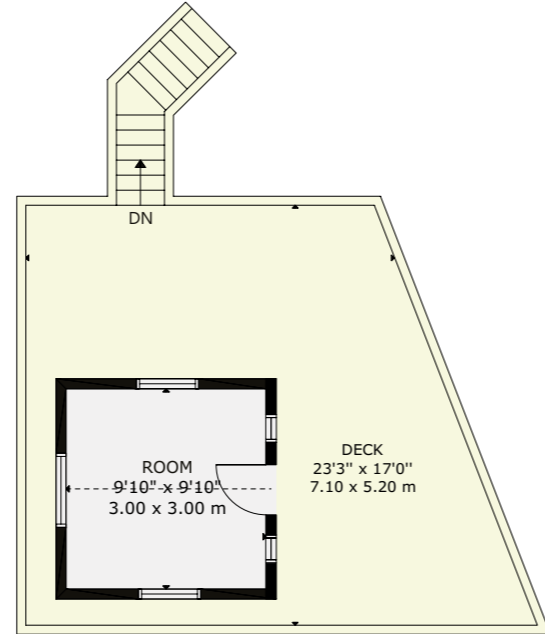

Tree House

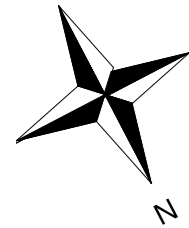



Land Plots

The property benefits from planning permission on two sections of land. These are divided in to a site c.1.5 acres which has granted planning for three individual homes as well as a c. 2 acre paddock with planning to create a large residential home with a pond and garaging.

Within the 1.5 acre site there is confirmation that there would be unrestricted use for the three properties under a residential consent so it would be possible to add further rental accommodation that could be let out in addition to Sandford Cottages. 11/05405/FULL

Planning Permission

1.5 acre plot - Ref. No: 10/03307/FULL - Planning permission in perpetuity for three detached residential houses Ref. No: 10/03307/FUL

2 acre paddock - Ref. No: 23/00893/ARC - Application for matters specified in conditions of planning permission in principle 21/001769/PPP for erection of a dwellinghouse and garage with formation of pond and associated access arrangement including associated drainage and landscape infrastructure

EPC Rating

C/D

Rateable Value

£16,300

Local Authority

Fife Council - <https://www.fife.gov.uk/>

Services

Mains water and electricity. Private drainage. LPG and ground source. There are no Section 75 payments due on the sites.

Third Party Rights and Servitudes

The subjects are sold together with and subject to all existing rights of way, servitudes, wayleaves and others whether contained in the Title Deeds or otherwise, and purchasers will be deemed as satisfied themselves in respect thereof.

Boundary

The site boundaries and vehicular access are shown on the site plan and images. All purchasers will be required to satisfy themselves with the legal boundaries as disclosed within the title deeds.

Viewing

By appointment through Knight Frank on 0131 222 9600.

Financial Guarantee/Anti Money Laundering

All offers to purchase the property (regardless of whether the offer is on a cash basis or subject to loan funding) must be accompanied with evidence of Source of Funds. This can be in the form of a bank statement showing the purchase price, a financial reference from a bank/funding source, or confirmation from a solicitor that the purchaser has sufficient funds to complete the purchase. In addition, the purchaser must supply certified copies of his/her passport and confirmation of residence in terms acceptable under anti money laundering (AML) legislation. These documents will be required for all individuals who will appear on the title once the transaction is complete.

Knight Frank Edinburgh
80 Queen Street
Edinburgh
EH2 4NF
[knightfrank.co.uk](https://www.knightfrank.co.uk)

We would be delighted to tell you more

Neil Scott
0131 222 9600
neil.scott@knightfrank.com

Rosi Dow
0131 222 9600
rosi.dow@knightfrank.com

Fixtures and fittings: A list of the fitted carpets, curtains, light fittings and other items fixed to the property which are included in the sale (or may be available by separate negotiation) will be provided by the Seller's Solicitors.

Important Notice: 1. Particulars: These particulars are not an offer or contract, nor part of one. You should not rely on statements by Knight Frank LLP in the particulars or by word of mouth or in writing ("information") as being factually accurate about the property, its condition or its value. Neither Knight Frank LLP nor any joint agent has any authority to make any representations about the property, and accordingly any information given is entirely without responsibility on the part of the agents, seller(s) or lessor(s). 2. Photos, Videos etc: The photographs, property videos and virtual viewings etc. show only certain parts of the property as they appeared at the time they were taken. Areas, measurements and distances given are approximate only. 3. Regulations etc: Any reference to alterations to, or use of, any part of the property does not mean that any necessary planning, building regulations or other consent has been obtained. A buyer or lessee must find out by inspection or in other ways that these matters have been properly dealt with and that all information is correct. 4. VAT: The VAT position relating to the property may change without notice. 5. To find out how we process Personal Data, please refer to our Group Privacy Statement and other notices at <https://www.knightfrank.com/legals/privacy-statement>. Particulars dated August 2024. Photographs and videos dated August 2024.

All information is correct at the time of going to print. Knight Frank is the trading name of Knight Frank LLP. Knight Frank LLP is a limited liability partnership registered in England and Wales with registered number OC305934. Our registered office is at 55 Baker Street, London W1U 8AN. We use the term 'partner' to refer to a member of Knight Frank LLP, or an employee or consultant. A list of members names of Knight Frank LLP may be inspected at our registered office. If you do not want us to contact you further about our services then please contact us by either calling 020 3544 0692, email to marketing.help@knightfrank.com or post to our UK Residential Marketing Manager at our registered office (above) providing your name and address. Brochure by wordperfectprint.com



