

DO NOT SCALE

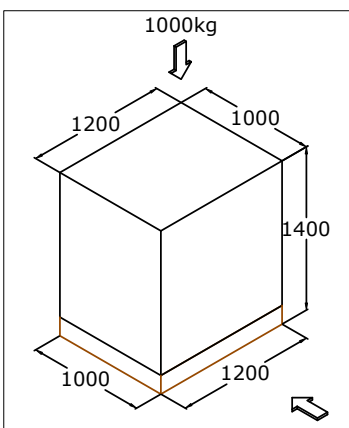

Note :  
Load Type : L1 Pallet  
Capacity : 22626 Pallet(s)

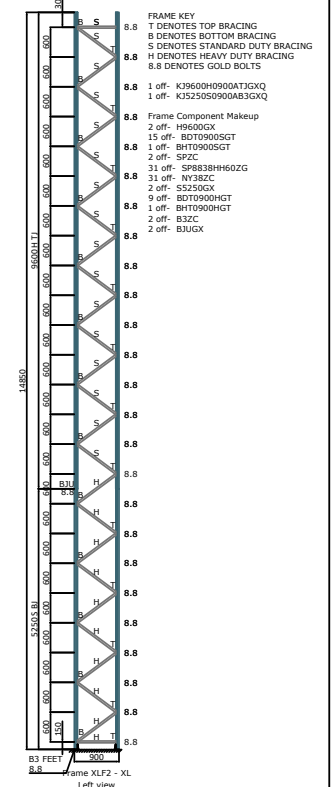
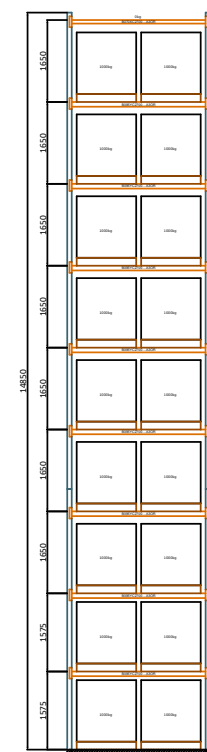
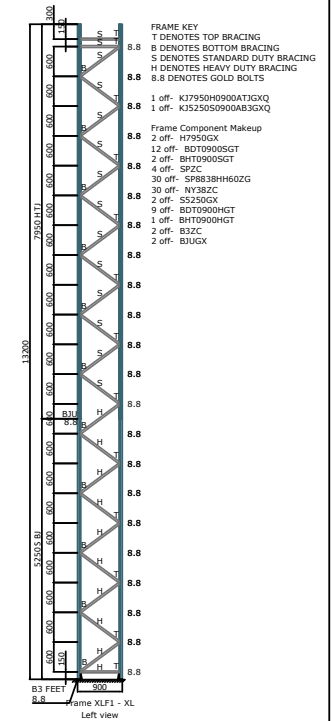
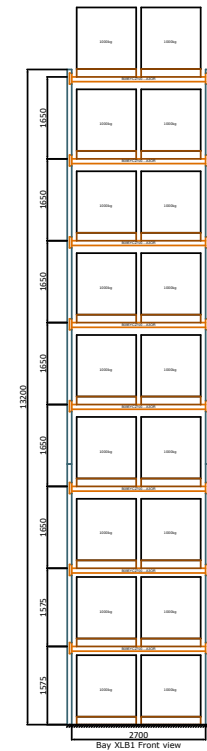
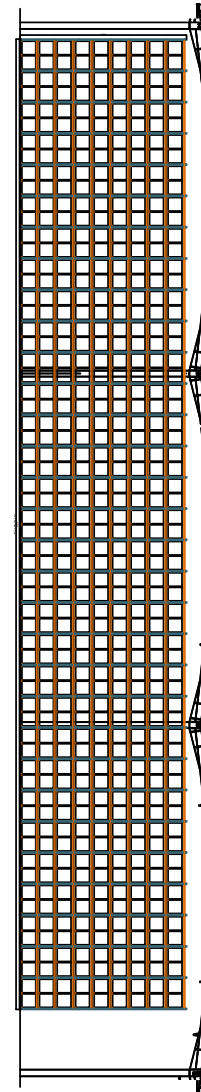
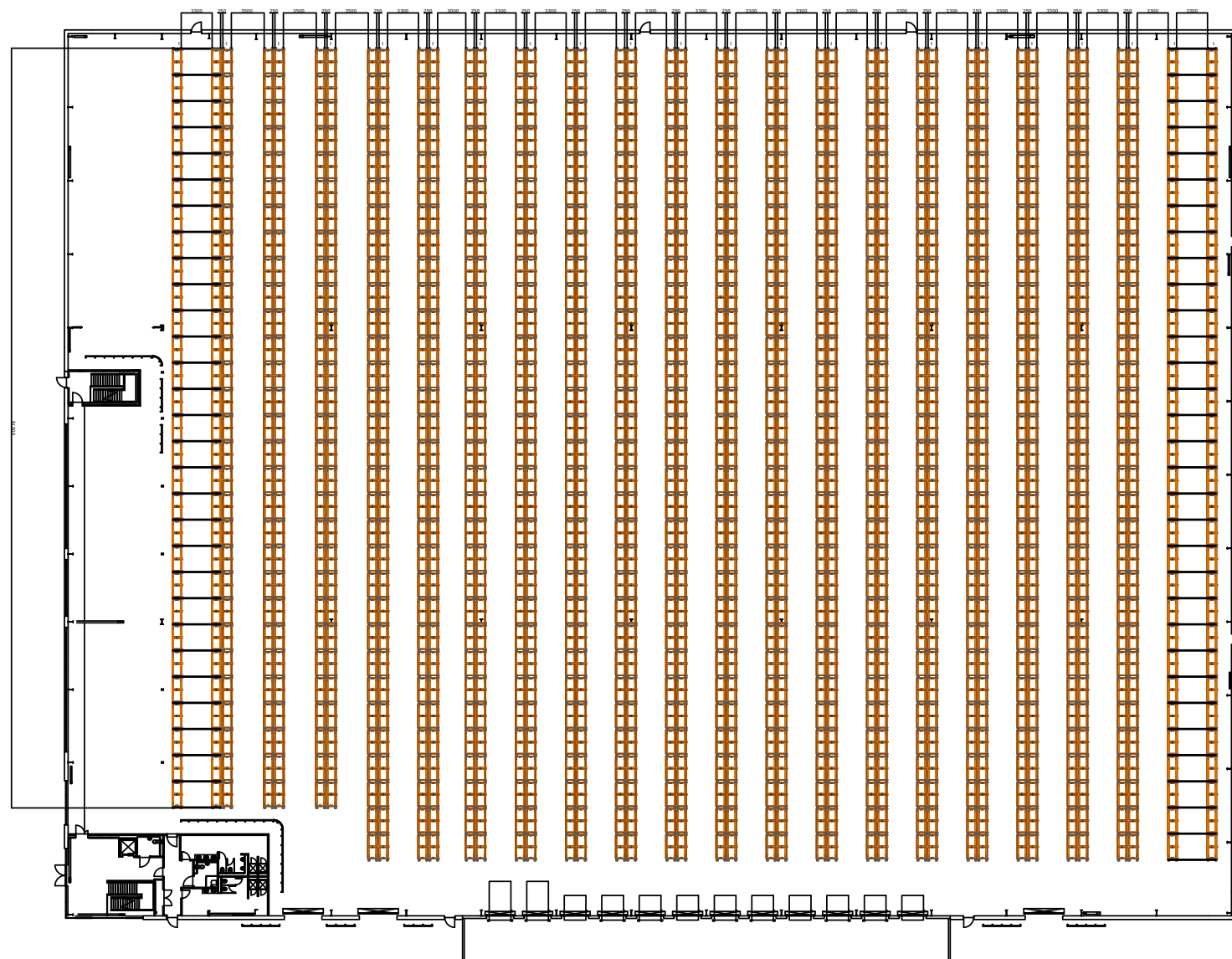

**Whittan Group Ltd.**  
Link House, Halesfield 6, Telford, TF7 4LN, United Kingdom  
www.whittan.com <http://www.whittan.com> T: +44 (0)1952 682 251

Rev No.	Date	Sign	Description







Storage Solution for  
Sherburn Project - Firethorn Trust UNIT 300 Wide Aisles

This Drawing remains the property of Whittan Group ©

Scale:	Drawn By: PDL	Checked By: JR	Date: 08/12/2023	Customer Approval:	Approval Date:
<small>While every attempt has been made to ensure the accuracy of the drawing contained here, measurements are indicative only and no responsibility is taken for any error, omission, or misstatement. The drawing is for initial guidance only and should not be relied on for any other purpose. Specifically, no guarantee is given as towards the accuracy of this drawing. On receipt of any formal instructions to proceed with a project the drawing/ drawings will be checked and subject to the Terms &amp; Conditions agreed. Copyright of the document remains vested with Whittan Industrial Ltd</small>				Drawing and Contract number: A3 D360-57428-00022-00	