

THE HOW

EXCLUSIVE GREEN LIVING





EXCLUSIVE

SET WITHIN 17 ACRES OF STUNNING PARKLAND, WE ARE CREATING A PRIVATE GATED COMMUNITY THAT IS IN COMPLETE HARMONY WITH THE BEAUTIFUL COUNTRYSIDE THAT SURROUNDS IT.

WITH A MIX OF TENDED AREAS AND MORE WILD AREAS LEFT TO NATURE, FOR EVERYONE TO ENJOY. HOMES AND POCKETS OF ACTIVITY SIT ALONG A CONNECTING SPINE THAT LINK THE 5 HECTARES OF HOUGHTON MEADOW WITHIN THE HISTORIC GROUNDS OF THE HOW ITSELF.

EVERY HOME WILL BE AT THE LEADING EDGE OF ENERGY EFFICIENCY AND SUSTAINABILITY, WITH CLEVER BUT DISCRETE TECHNOLOGY GENERATING POWER AND MANAGING THE TEMPERATURE AND AIR QUALITY, SO THAT YOU CAN LIVE HEALTHY, HAPPY LIVES WITH A CLEAR CONSCIENCE.

THE TIMING IS PERFECT. TRENDS IN WORK HAVE CHANGED FOR THE BETTER. EMPLOYERS SEE THE NEED FOR PEOPLE TO WORK AWAY FROM THE OFFICE - OFTEN ACTIVELY ENCOURAGING IT, AT LEAST FOR PART OF THE WEEK - AND PEOPLE ARE MORE PRODUCTIVE AND HAPPIER WHEN THEY HAVE A BETTER WORK/LIFE BALANCE.

ADDITIONALLY, MORE AND MORE PEOPLE ARE CHOOSING TO LEAVE THE DAILY COMMUTE BEHIND ALTOGETHER AND WORK FOR THEMSELVES, FREELANCING, CONSULTING, OR STARTING CREATIVE BUSINESSES ON THEIR OWN TERMS.

THE HOW
EXCLUSIVE GREEN LIVING
EXCLUSIVE GREEN LIVING



GREEN

THE UNIQUE COUNTRYSIDE SETTING IS SO BEAUTIFUL, WE COMMITTED AT THE START TO WORK WITH IT, NOT AGAINST IT. IT WOULD BE EASY TO FLATTEN IT AND BUILD JUST ANOTHER HOUSING ESTATE... BUT THE HOW IS DESTINED TO BE VERY DIFFERENT AND LEAVE A LONG-LASTING LEGACY WHICH WILL BE ADMIRER BY GENERATIONS TO COME.

HISTORIC TRAILS AND BRIDLEWAYS ARE CONNECTED TO THE DESIGN. STEP OUT OF YOUR FRONT DOOR, TURN A CORNER AND WITHIN MINUTES YOU CAN BE OUT IN NATURE, WITH PICTURESQUE COUNTRYSIDE WALKS TO EXPLORE AT YOUR LEISURE.

HOMES ARE RIGHT FOR TODAY AND READY FOR TOMORROW — CONTEMPORARY, CLEAN, AND MODERN WITH A FABRIC FIRST APPROACH THAT ENSURES A COMFORTABLE, LOW-ENERGY HOME FOR LIFE.

'FABRIC FIRST' MAY NOT BE A TERM YOU'RE FAMILIAR WITH, BUT IT IS CHANGING THE WAY NEW HOMES ARE DESIGNED AND BUILT. FABRIC FIRST USES CUTTING EDGE DESIGN, MATERIAL TECHNOLOGIES AND SPECIALIST WORKMANSHIP TO MINIMISE THE NEED FOR HEATING AND COOLING, REDUCING HEAT LOSS AND INSULATING BEYOND INDUSTRY STANDARDS.

WE'RE ALSO MAKING BEST USE OF NATURAL LIGHT, MAXIMISING HEAT GAIN IN THE COOLER MONTHS AND REDUCING IT IN THE SUMMER, SO THAT HOMES CAN BE BOTH BEAUTIFUL AND ENERGY EFFICIENT — AESTHETIC DOESN'T NEED TO TAKE A BACK SEAT TO THE NEED TO REDUCE THE IMPACT OF A HOME THROUGHOUT ITS LIFE.

THE HOW
EXCLUSIVE GREEN LIVING
EXCLUSIVE LIVING

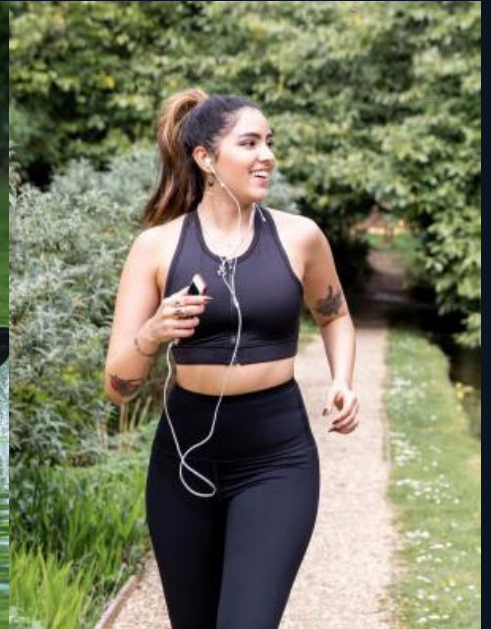

LIVING

THE HOW ITSELF IS SITUATED ADJACENT TO THE RIVER OUSE WITH A SHORT WALK TO THE THICKET PATH ACCESSED VIA A PRIVATE GATE FROM THE DEVELOPMENT AND IS IDEAL FOR CYCLING, RUNNING AND WATERSPORTS. THE GROUNDS THEMSELVES ARE PERFECT FOR EARLY MORNING WALKS OR SUNSET STROLLS THROUGH ITS BEAUTIFUL MATURE GARDENS. FOLLOW ON WITH A WALK THROUGH MEDIEVAL RIDGE AND FURROW MEADOWS BURSTING WITH WILDFLOWERS SO RARE, THEY'VE BEEN DESIGNATED A SITE OF SPECIAL SCIENTIFIC INTEREST.

HEMINGFORD MEADOW, DESCRIBED BY DANIEL DEFOE IN 1724/6 AS 'THE MOST BEAUTIFUL IN ANY PART OF ENGLAND, ONE OF THE MOST AGREEABLE SIGHTS OF ITS KIND IN THE WHOLE WORLD', OVERLOOKS THE TOWN. ALSO ACCESSED FROM THE TOWN, NEAR THE GRADE 1 LISTED PARISH CHURCH OF ALL SAINTS, IS HOLT ISLAND NATURE RESERVE, ONCE AN IMPORTANT SOURCE OF WILLOW OSIERS FOR BASKET MAKING. THIS GREEN WALK OF JUST OVER 2 MILES (5,000 STEPS) IS ALONG A RIVERSIDE FOOTPATH TO CLIMB A TRACK THROUGH WOODLAND, THROUGH A STILE AND INTO AN OPEN FIELD. FOLLOW WITH AN AMBLE THROUGH ANCIENT AND UNSPOILT MEADOWS. TRANQUIL PLACES TO SIT, REST AND HAVE A PICNIC. VERY HIGH COUNT OF WILD FLOWERS, INSECTS AND BIRDLIFE.

[CLICK HERE TO WATCH OUR LOCAL AREA](#)

THE HOW
EXCLUSIVE GREEN LIVING
EXCLUSIVE LIVING



OUR GREEN HOMES AT THE HOW

SUSTAINABLE TIMBER FRAME CONSTRUCTION WITH ALL ROUND IMPROVED THERMAL PERFORMANCE. DOUBLE LAYER OF INSULATION.

AIR SOURCE HEAT PUMP -USES THE ENVIRONMENT TO GENERATE 75% OF THE HEATING AND HOT WATER NEEDS FOR YOUR NEW HOME. A RENEWABLE ENERGY SOURCE IS FUTURE PROOF AND SUSTAINABLE.

SOLAR ELECTRICITY PANELS - ALSO KNOWN AS PHOTOVOLTAICS (PV), CAPTURE THE SUN'S ENERGY AND CONVERT IT INTO ELECTRICITY. THESE PANELS WILL BE SEAMLESSLY BUILT INTO THE ROOF FABRIC. A RENEWABLE ENERGY SOURCE TO REDUCED YOUR CARBON FOOTPRINT AND ANNUAL ENERGY COSTS.

WATER SAVING APPLIANCES - DUAL FLUSH TOILETS, AERATED FLOW TAPS AND SHOWER TAPS, WATER EFFICIENT WASHING MACHINES - ENSURING A REDUCTION OF UP TO 40% LESS WATER WASTE.

NO GAS CONNECTION, REDUCING THE USE OF FOSSIL FUELS AND OVERALL ENERGY COSTS.

LED LIGHTING AND ENERGY EFFICIENT APPLIANCES, WIRED FOR INTELLIGENT HOME SOLUTIONS.

WE STRIVE AT THE HOW TO ACHIEVE AN A RATING IN EPC (ENERGY PERFORMANCE CERTIFICATE) TO ALL OUR NEW BUILD HOMES, THROUGH THE CONSTRUCTION OF THE FABRIC AND RENEWABLE FEATURES.

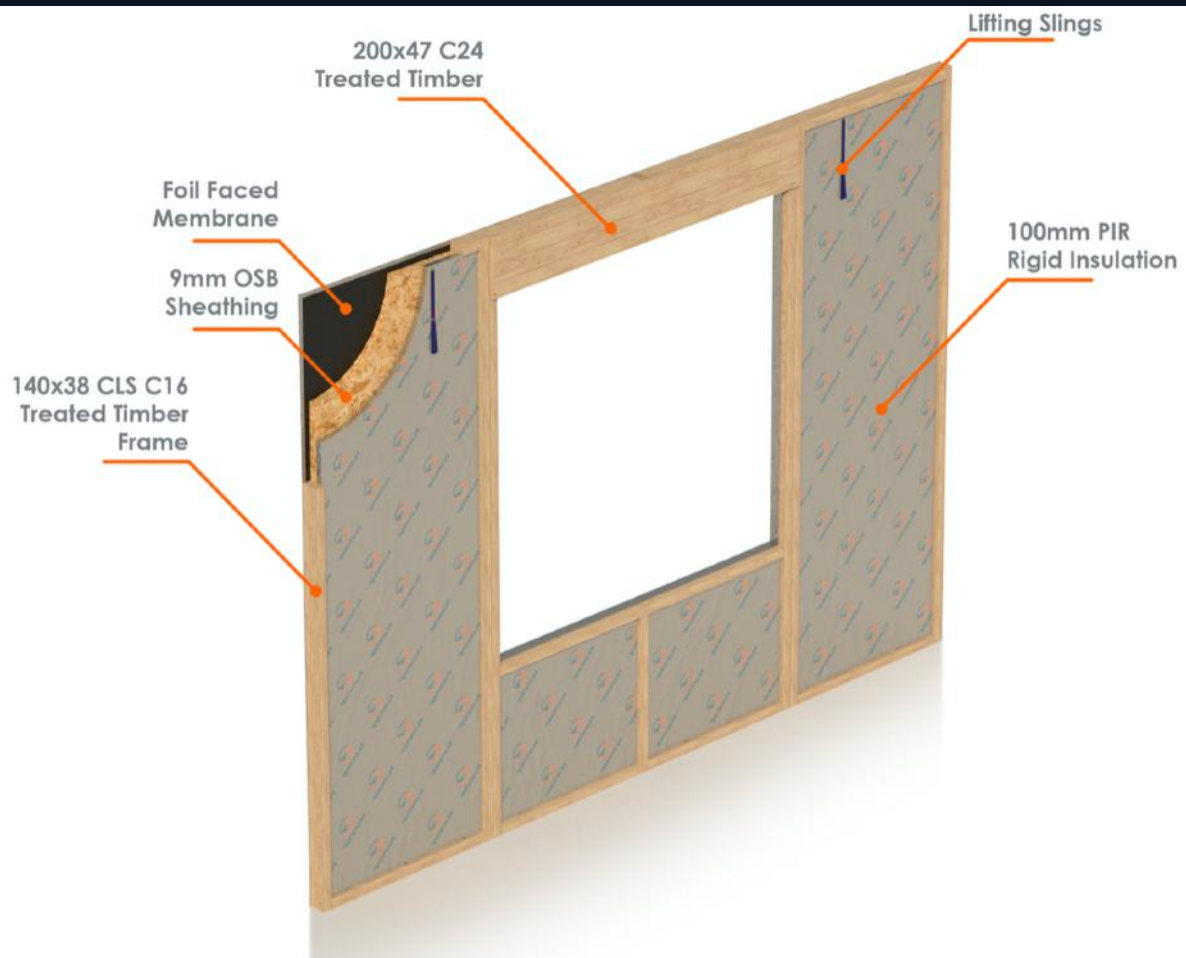

TIMBER FRAME CONSTRUCTION

WHAT'S GREAT ABOUT TIMBER MATERIALS IS THAT THEY ARE A NATURAL INSULATOR. WHEN INSTALLED FOR YOUR WINDOWS, DOORS, AND FLOORS, THEY HELP REGULATE THE TEMPERATURE AT HOME TO MAINTAIN A COMFORTABLE LIVING SPACE. AS THEY NATURALLY HAVE THERMAL INSULATING PROPERTIES, THEY LIMIT THE ABILITY TO CONDUCT HEAT. FOR THIS REASON, THEY REDUCE ENERGY CONSUMPTION FOR HEATING OR COOLING TO BOOST YOUR HOME'S OVERALL ENERGY EFFICIENCY.

CONTRARY TO POPULAR NOTION, A TIMBER FRAME IS HIGHLY DURABLE AND STRONG. AS LONG AS HIGH-QUALITY WOOD STRUCTURES ARE PROPERLY INSTALLED, THEY WILL LAST FOR AS LONG AS POSSIBLE. IN FACT, CERTAIN TYPES OF WOOD AND WELL-MADE TIMBER STRUCTURES CAN LAST FOR CENTURIES. ALONG WITH THIS ATTRIBUTE IS THAT IT IS RELATIVELY EASY AND CHEAP TO MAINTAIN. WHETHER YOU WANT TO CHANGE ITS COLOUR OR ADD ANOTHER LAYER OF STRENGTH, YOU CAN DO SO RATHER QUICKLY AND EASILY!

OPTING FOR A WOOD FRAME MAKES ALL THE DIFFERENCE IN YOUR CONSTRUCTION PROJECT. FOR ONE, IT IS ECOLOGICAL AND SUSTAINABLE AS A RENEWABLE BUILDING MATERIAL, MEANING THAT IT CAN BE RECYCLED AND SUSTAINED IF THE LOCALS STRICTLY OBSERVE ECOLOGY CONSERVATION, SUCH AS PLANTING MORE TREES. TWO, IT IS ENVIRONMENTALLY FRIENDLY. AS A NON-TOXIC, NATURAL MATERIAL, IT DOESN'T UNLEASH CHEMICALS INTO THE AIR, COMPROMISE PEOPLE'S HEALTH, AND NEGATIVELY IMPACT THE ENVIRONMENT.

360 DEGREE SITE TOUR



[Click here to take our 360 tour](#)

TAKE OUR 360 TOUR OF THIS FANTASTIC SITE. SIMPLY TAP THE LINK ABOVE AND SWIPE AROUND EACH AREA. TO MOVE FROM ONE SPACE TO THE NEXT TAP ON THE TARGET POINTS THROUGHOUT THE 360 TOUR.

THE HOW
EXCLUSIVE GREEN LIVING

THE HOMES



C1 HOUSE TYPE - PLOT 13, 14, 15 & 19
GUIDE PRICE £1,000,000 - £1,025,000

SAT ON A ¼ OF ACRE PLOT AND SET OVER 3 FLOORS, THE C1'S ARE BUILT TO AN UNPARALLELED STANDARD WITH BREATH-TAKING FINISHES AND SPECIFICATIONS OF THE HIGHEST QUALITY THROUGHOUT. WITH EXCEPTIONAL ENERGY EFFICIENCY, THESE HOUSES OFFER AN OUTSTANDING LIFESTYLE AND AN EXPERIENCE WHILST IMMERSSED IN MANICURED PARKLAND GARDENS

[C1 PROPERTY VIDEO - CLICK HERE](#)

THE HOW
EXCLUSIVE GREEN LIVING

C1

C1 HOUSE TYPE HOUSE SPECIFICATIONS

KITCHEN

- A CHOICE OF LEADING GERMAN HACKER KITCHEN UNIT AND DOORS.
 - BLANCO UNDERMOUNTS SUBLINE 480/320-U 2 BOWL UNDERMOUNT SINK, LH BOWL WHITE
 - QUOOKER OR SIMILAR HOT TAP
 - CAPLE APPLIANCES SENSE WINE CABINET
 - SIEMENS OR SIMILAR BUILT IN OVEN
 - SIEMENS OR SIMILAR BUILT IN COMBI MICROWAVE OVEN
 - SIEMENS OR SIMILAR BUILT IN DISHWASHER
 - SIEMENS OR SIMILAR BUILT IN FRIDGE
 - SIEMENS OR SIMILAR BUILT IN FREEZER
- FEATURE UNITS INCLUDE, PULL RECYCLING BINS AND CUTLERY DRAWER
- CHOICE OF 30MM QUARTZ WORKTOP

BATHROOMS AND EN-SUITE(S)

- HIGH QUALITY CONTEMPORARY BESPOKE WHITE SANITARY WARE
- WALL HUNG WC'S WITH SOFT CLOSERS
- THERMOSTATIC MIXERS TO ALL SHOWERS AND BATHS
- TOWEL RADIATORS IN ALL BATHROOMS
- PORCELAIN WALL AND FLOOR TILES TO ALL BATHROOMS
- FREE STANDING BATHS AND WALK IN SHOWERS

INTERNAL FINISHES

- WOOD GRAIN BESPOKE DOORS
- SATIN CHROME DOOR FURTHER
- HANDMADE AND PAINTED SKIRTINGS AND ARCHITRAVES
- INSULATED PLASTERBOARD AND SKIMMING THROUGHOUT
- BESPOKE WALNUT, GLASS AND STEEL (ANTHRACITE COLOUR) STAIRCASE AND BALUSTRADE
- VELFAC LOW PROFILE WINDOWS AND DOORS IN ANTHRACITE (EXTERNAL) AND WHITE (INTERNAL)

EXTERNAL FINISHES

- GRAVEL AND BLOCK PAVED DRIVEWAY
- INDIAN SANDSTONE PATIOS AND PATHS
- BLACK HAND-PAINTED SIBERIAN LARCH CLADDING AND BRICKWORK EXTERIOR FINISH
- HAND CRAFTED ZINC DORMER WINDOWS AND ALUMINIUM PORCH
- DETACHED DOUBLE GARAGE, BIKE STORE AND SHED WITH ELECTRIC ROLLER SHUTTER DOOR TO DOUBLE GARAGE (JUST FOR THE C1)

HEATING AND WATER SYSTEMS

- AIR-SOURCE HEAT PUMP CENTRAL HEATING SYSTEM
- OPTION TO ENABLE WIFI CONTROL THROUGHOUT
- UNDERFLOOR HEATING THROUGHOUT GROUND FLOOR
- COMPACT RADIATORS TO FIRST FLOOR WITH OPTION TO ENABLE WIFI CONTROL
- PRESSURED HOT WATER SYSTEM
- OUTSIDE TAP

ELECTRICAL

- MOTION ACTIVATED LIGHT SENSORS TO BATHROOMS
- LOW ENERGY LED DOWNLIGHTING THROUGHOUT (OPTION TO CONTROL THROUGH WIFI)
- OUTSIDE POWER POINTS
- EXTERNAL WALL LOW ENERGY LED LIGHTS TO FULL PERIMETER OF THE DWELLING AND GARAGE (DUSK TIL DAWN SENSOR)
- LANDSCAPED GARDEN LIGHTING (DUSK TIL DAWN SENSOR)

INTERNET AND TV

- CCTV WIRING THROUGHOUT
- FULLY WIRED FOR CRESTRON OR CONTROL 4 SYSTEM THROUGHOUT TO INCLUDE ALL TV AND SPEAKER POSITIONS
- CAT 6 AND HDMI OUTPUTS THROUGHOUT

C1



[CLICK HERE TO FIND OUT MORE ABOUT OUR KITCHENS & BATHROOMS](#)

THE HOW
EXCLUSIVE GREEN LIVING

C1 GREEN LIVING

Predicted Energy Assessment

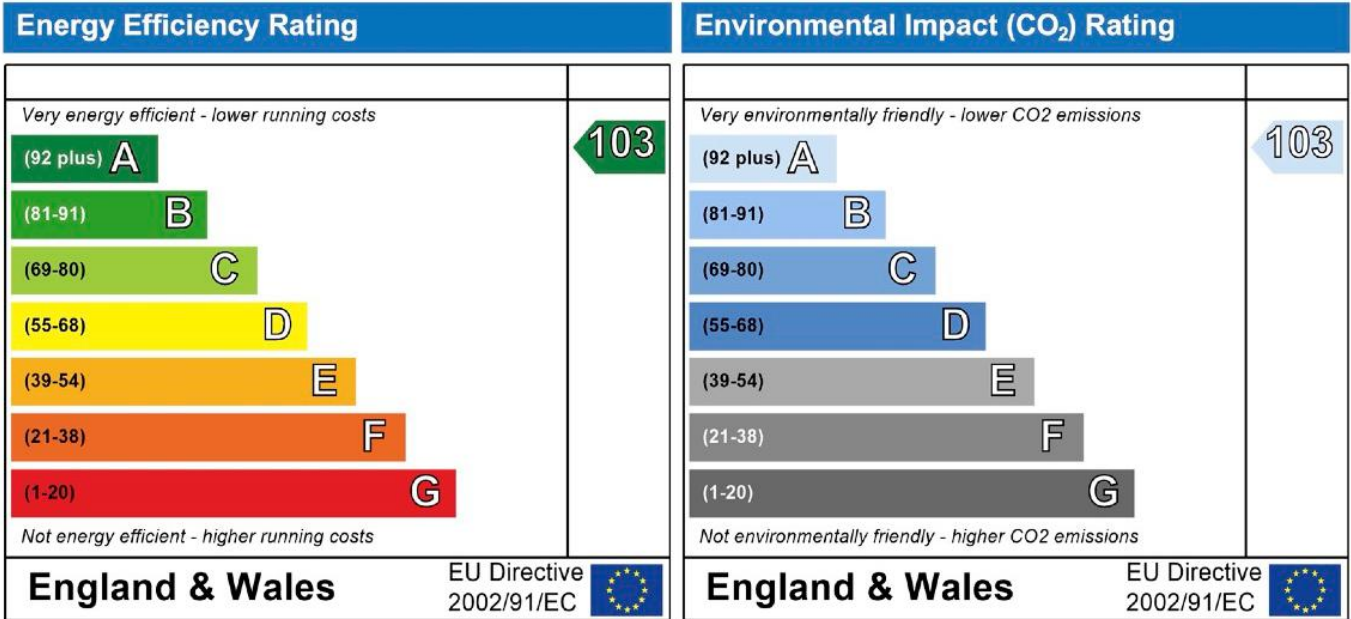

The energy efficiency rating is a measure of the overall efficiency of a home. The higher the rating the more energy efficient the home is and the lower the fuel bills are likely to be.

The environmental impact rating is a measure of a home's impact on the environment in terms of carbon dioxide (CO₂) emissions. The higher the rating the less impact it has on the environment.

Estimate Running Costs – C1			
Item	Energy Usage	Cost per Unit	Total Cost
Space Heating	2147.79 kWh/year	20.43p/kWh	£438.79 per year
Water Heating	477.57 kWh/year	20.43p/kWh	£97.57 per year
Energy For Pumps and Fans	189.65 kWh/year	20.43p/kWh	£38.75 per year
Energy for Lighting	641.91 kWh/year	20.43p/kWh	£131.14 per year
TOTAL COST:			£706.25 per year

C1

GROUND FLOOR

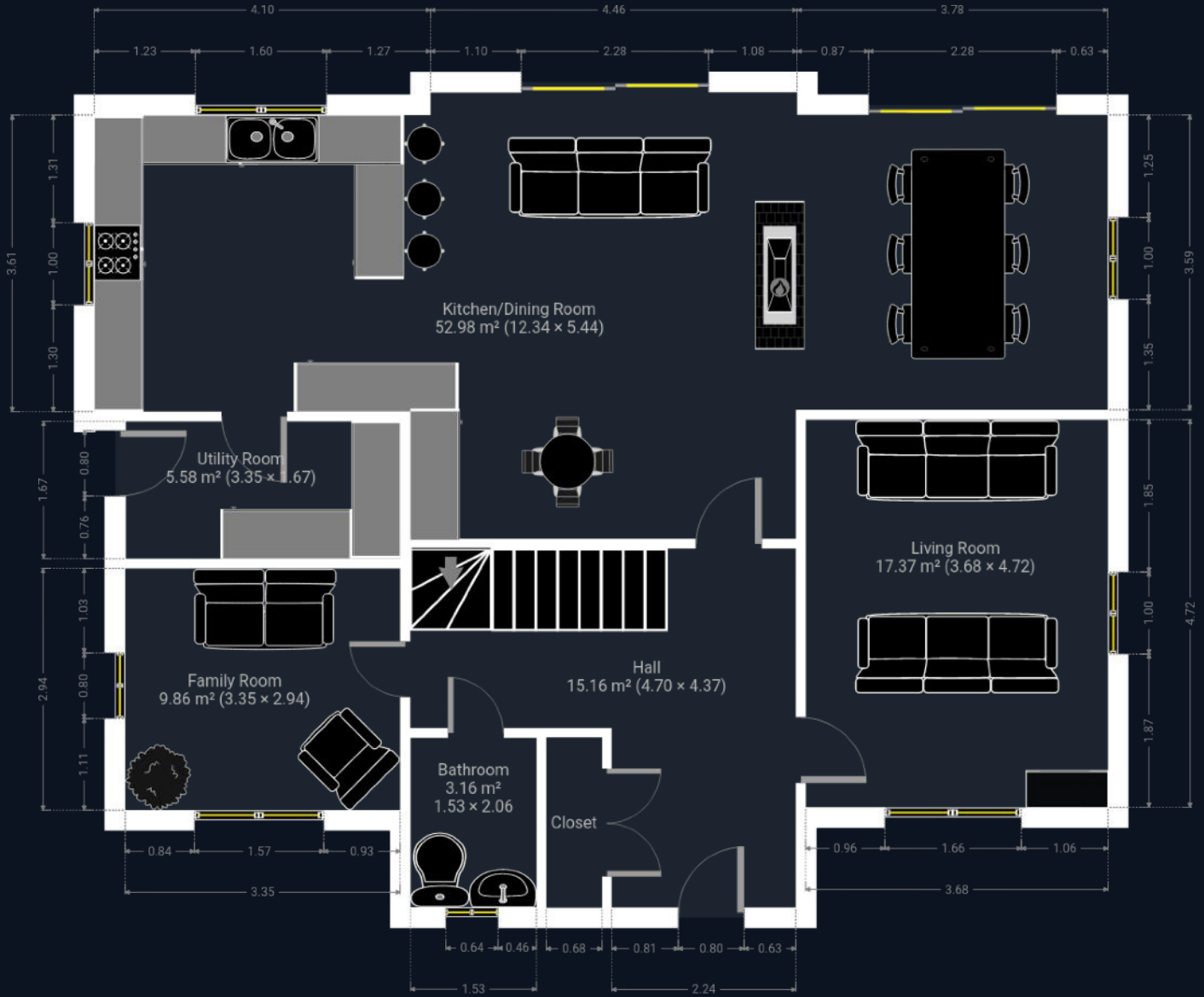

C1

SECOND FLOOR

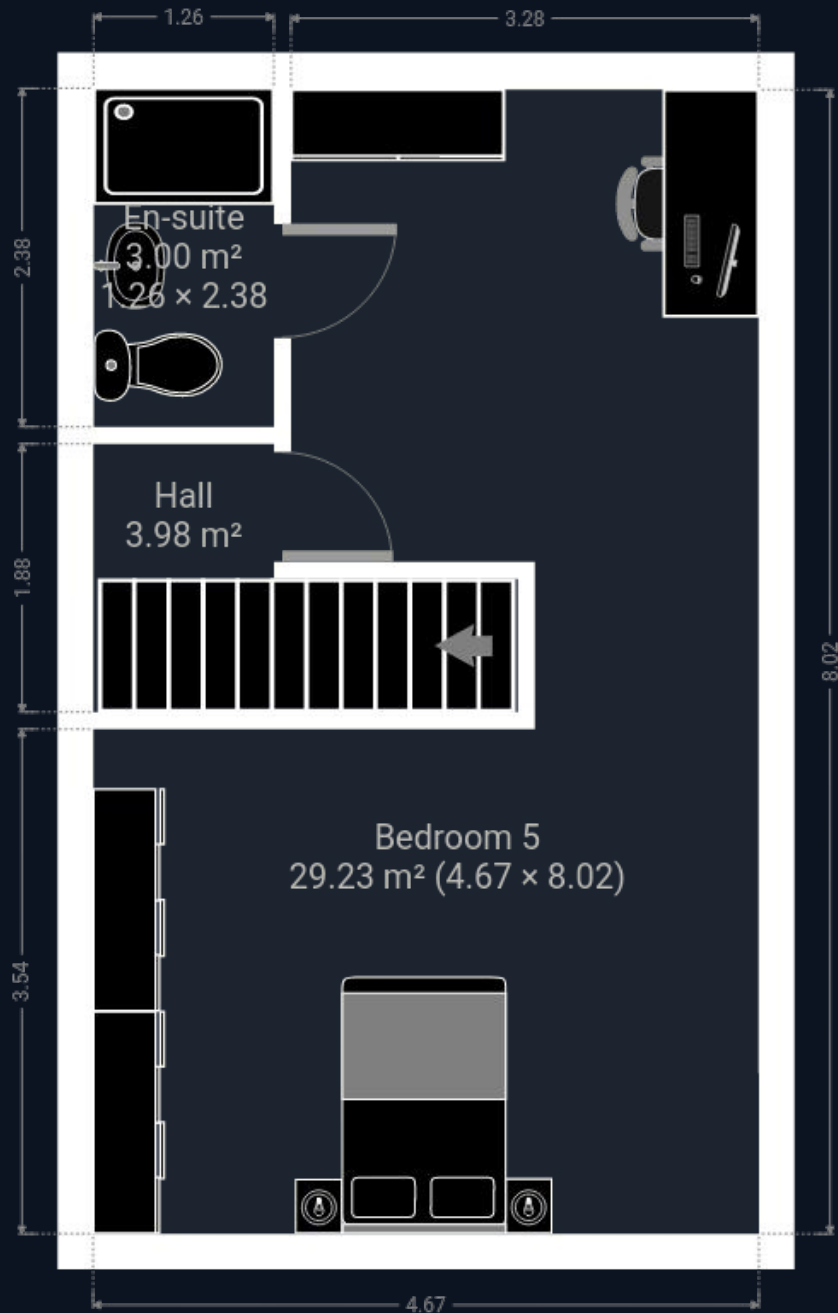

C1 GARAGE

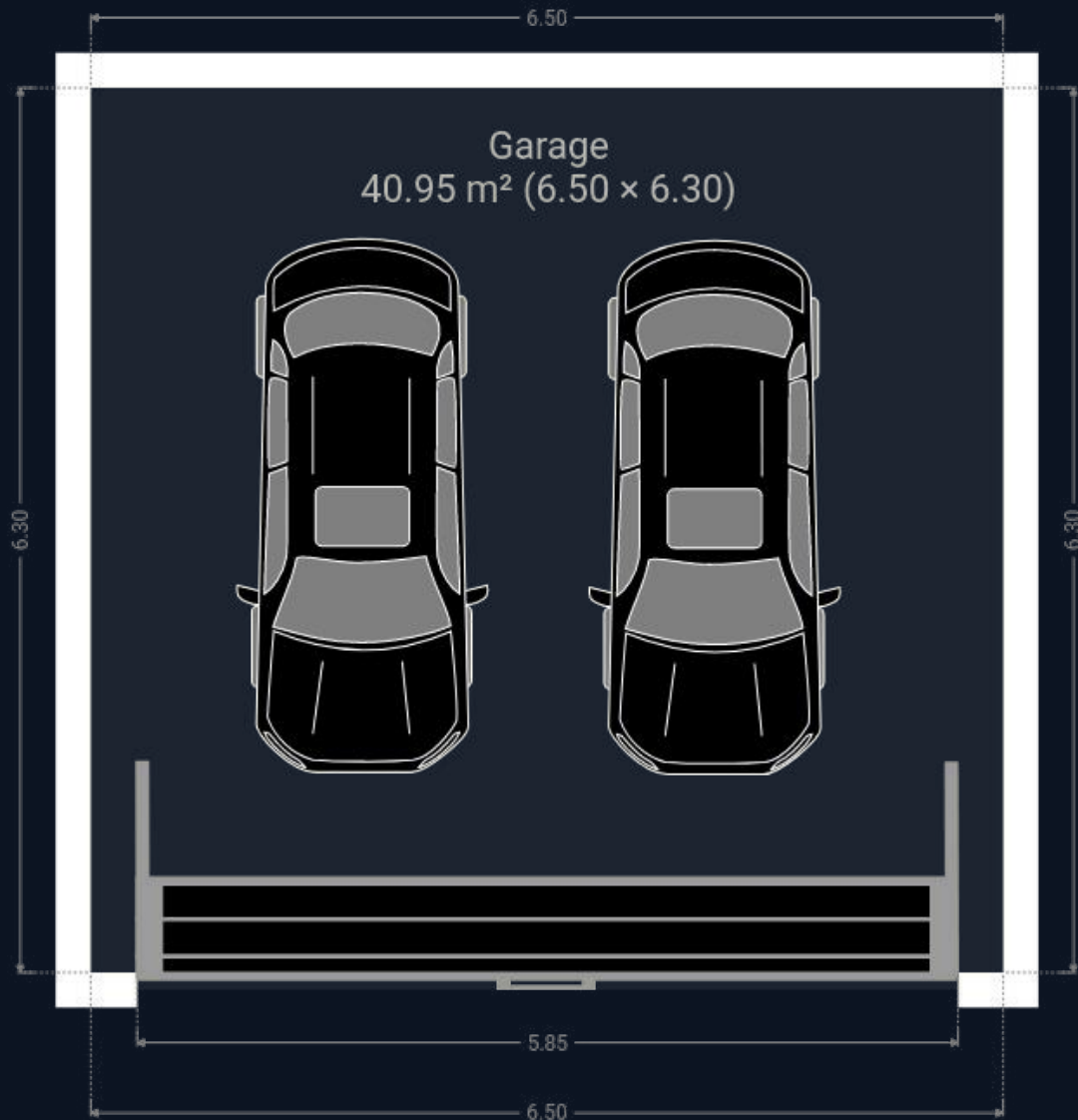

THE HOMES



B1 HOUSE TYPE 5 BEDROOM - PLOT 10 & 18
GUIDE PRICE £950,000

UNRIVALLED AND UNINTERRUPTED VIEWS, WHETHER IT BE BEAUTIFUL MORNING SUNRISES TO OUTSTANDING SUNSETS ON YOUR OWN PRIVATE BALCONY. WITH EXCEPTIONAL ENERGY EFFICIENCY, THESE HOUSES OFFER AN OUTSTANDING LIFESTYLE AND AN EXPERIENCE WHILST IMMERSSED IN MANICURED PARKLAND GARDENS

[B1 PROPERTY VIDEO - CLICK HERE](#)

THE HOW
EXCLUSIVE GREEN LIVING

B1

B1 HOUSE TYPE HOUSE SPECIFICATIONS

KITCHEN

- A CHOICE OF LEADING GERMAN HACKER KITCHEN UNIT AND DOORS.
 - BLANCO UNDERMOUNTS SUBLINE 480/320-U 2 BOWL UNDERMOUNT SINK, LH BOWL WHITE
 - QUOOKER OR SIMILAR HOT TAP
 - CAPLE APPLIANCES SENSE WINE CABINET
 - SIEMENS OR SIMILAR BUILT IN OVEN
 - SIEMENS OR SIMILAR BUILT IN COMBI MICROWAVE OVEN
 - SIEMENS OR SIMILAR BUILT IN DISHWASHER
 - SIEMENS OR SIMILAR BUILT IN FRIDGE
 - SIEMENS OR SIMILAR BUILT IN FREEZER
- FEATURE UNITS INCLUDE, PULL RECYCLING BINS AND CUTLERY DRAWER
- CHOICE OF 30MM QUARTZ WORKTOP

BATHROOMS AND EN-SUITE(S)

- HIGH QUALITY CONTEMPORARY BESPOKE WHITE SANITARY WARE
- WALL HUNG WC'S WITH SOFT CLOSERS
- THERMOSTATIC MIXERS TO ALL SHOWERS AND BATHS
- TOWEL RADIATORS IN ALL BATHROOMS
- PORCELAIN WALL AND FLOOR TILES TO ALL BATHROOMS
- FREE STANDING BATHS AND WALK IN SHOWERS

INTERNAL FINISHES

- WOOD GRAIN BESPOKE DOORS
- SATIN CHROME DOOR FURTHER
- HANDMADE AND PAINTED SKIRTINGS AND ARCHITRAVES
- INSULATED PLASTERBOARD AND SKIMMING THROUGHOUT
- BESPOKE WALNUT, GLASS AND STEEL (ANTHRACITE COLOUR) STAIRCASE AND BALUSTRADE
- VELFAC LOW PROFILE WINDOWS AND DOORS IN ANTHRACITE (EXTERNAL) AND WHITE (INTERNAL)

EXTERNAL FINISHES

- GRAVEL AND BLOCK PAVED DRIVEWAY
- INDIAN SANDSTONE PATIOS AND PATHS
- BLACK HAND-PAINTED SIBERIAN LARCH CLADDING AND BRICKWORK EXTERIOR FINISH
- HAND CRAFTED ZINC DORMER WINDOWS AND ALUMINIUM PORCH
- DETACHED DOUBLE GARAGE, BIKE STORE AND SHED WITH ELECTRIC ROLLER SHUTTER DOOR TO DOUBLE GARAGE (JUST FOR THE C1)

HEATING AND WATER SYSTEMS

- AIR-SOURCE HEAT PUMP CENTRAL HEATING SYSTEM
- OPTION TO ENABLE WIFI CONTROL THROUGHOUT
- UNDERFLOOR HEATING THROUGHOUT GROUND FLOOR
- COMPACT RADIATORS TO FIRST FLOOR WITH OPTION TO ENABLE WIFI CONTROL
- PRESSURED HOT WATER SYSTEM
- OUTSIDE TAP

ELECTRICAL

- MOTION ACTIVATED LIGHT SENSORS TO BATHROOMS
- LOW ENERGY LED DOWNLIGHTING THROUGHOUT (OPTION TO CONTROL THROUGH WIFI)
- OUTSIDE POWER POINTS
- EXTERNAL WALL LOW ENERGY LED LIGHTS TO FULL PERIMETER OF THE DWELLING AND GARAGE (DUSK TIL DAWN SENSOR)
- LANDSCAPED GARDEN LIGHTING (DUSK TIL DAWN SENSOR)

INTERNET AND TV

- CCTV WIRING THROUGHOUT
- FULLY WIRED FOR CRESTRON OR CONTROL 4 SYSTEM THROUGHOUT TO INCLUDE ALL TV AND SPEAKER POSITIONS
- CAT 6 AND HDMI OUTPUTS THROUGHOUT

B1



[CLICK HERE TO FIND OUT MORE ABOUT OUR KITCHENS & BATHROOMS](#)

THE HOW
EXCLUSIVE GREEN LIVING

B1 GREEN LIVING

Predicted Energy Assessment

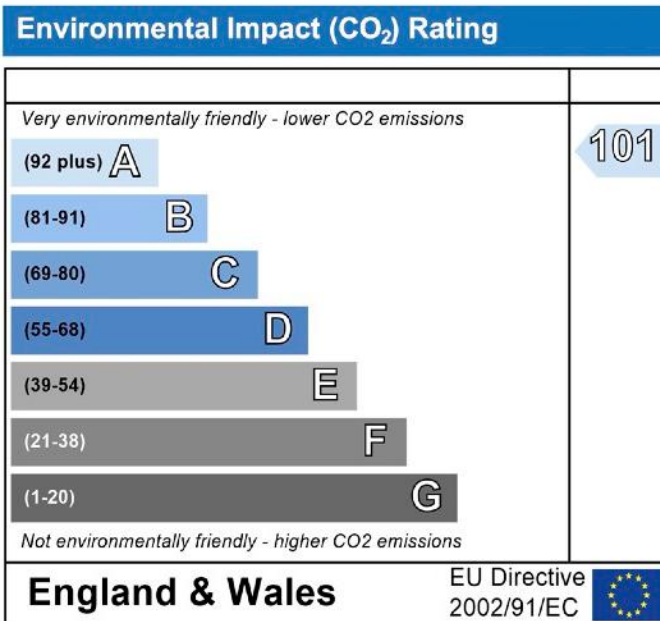
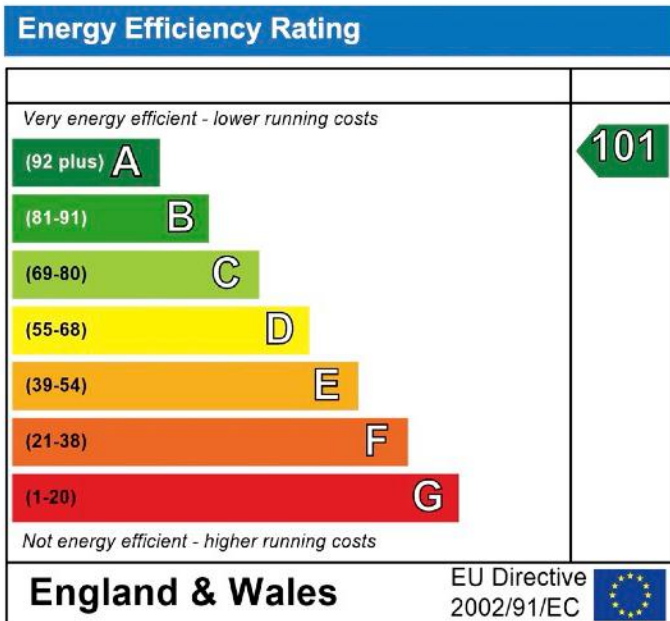

The energy efficiency rating is a measure of the overall efficiency of a home. The higher the rating the more energy efficient the home is and the lower the fuel bills are likely to be.

The environmental impact rating is a measure of a home's impact on the environment in terms of carbon dioxide (CO₂) emissions. The higher the rating the less impact it has on the environment.

Estimate Running Costs – B1

Item	Energy Usage	Cost per Unit	Total Cost
Space Heating	2128.37 kWh/year	20.43p/kWh	£434.83 per year
Water Heating	564.30 kWh/year	20.43p/kWh	£115.29 per year
Energy For Pumps and Fans	184.27 kWh/year	20.43p/kWh	£37.65 per year
Energy for Lighting	616.59 kWh/year	20.43p/kWh	£125.97 per year
TOTAL COST:			£713.74 per year

B1 GROUND FLOOR

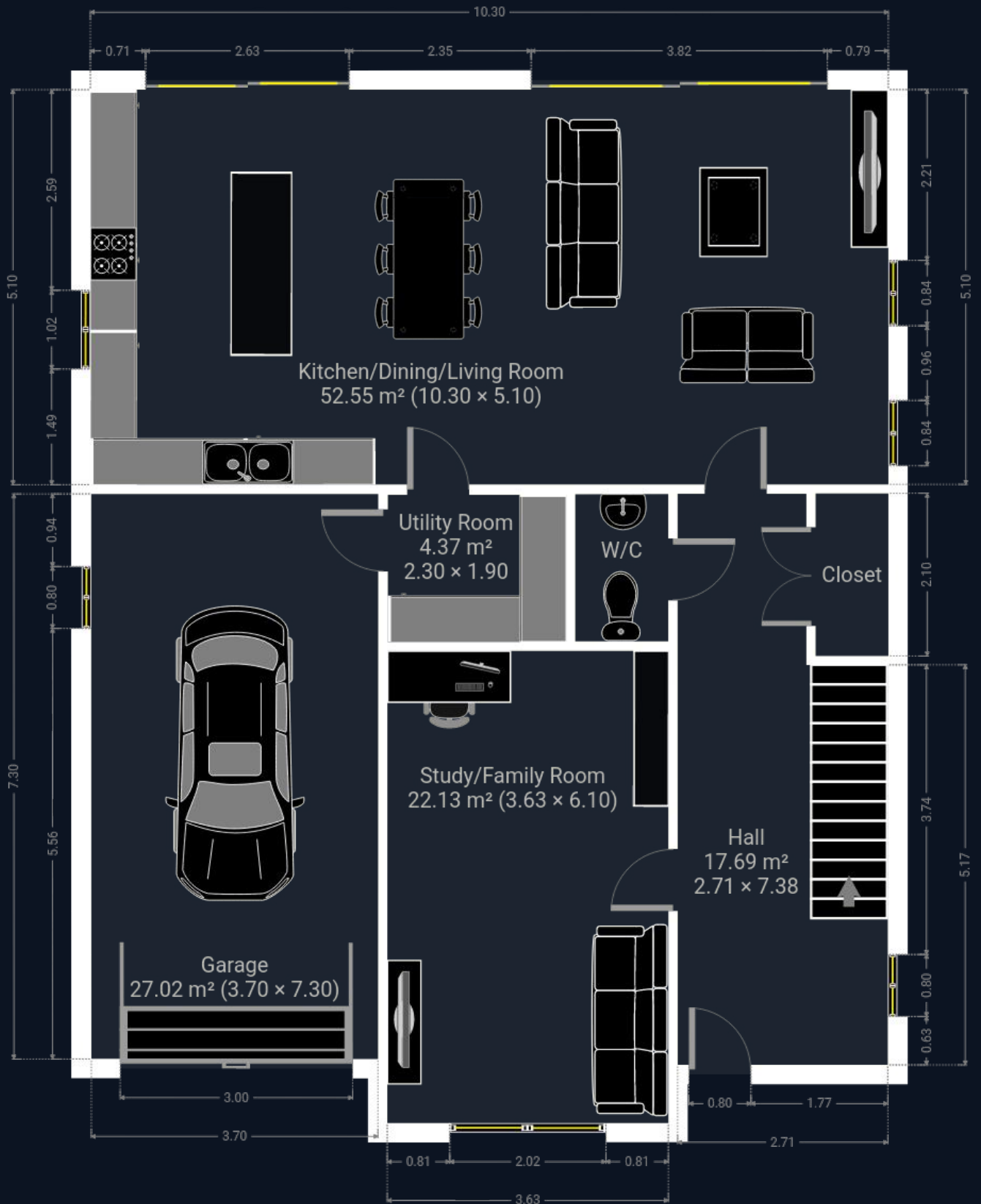

B1 FIRST FLOOR

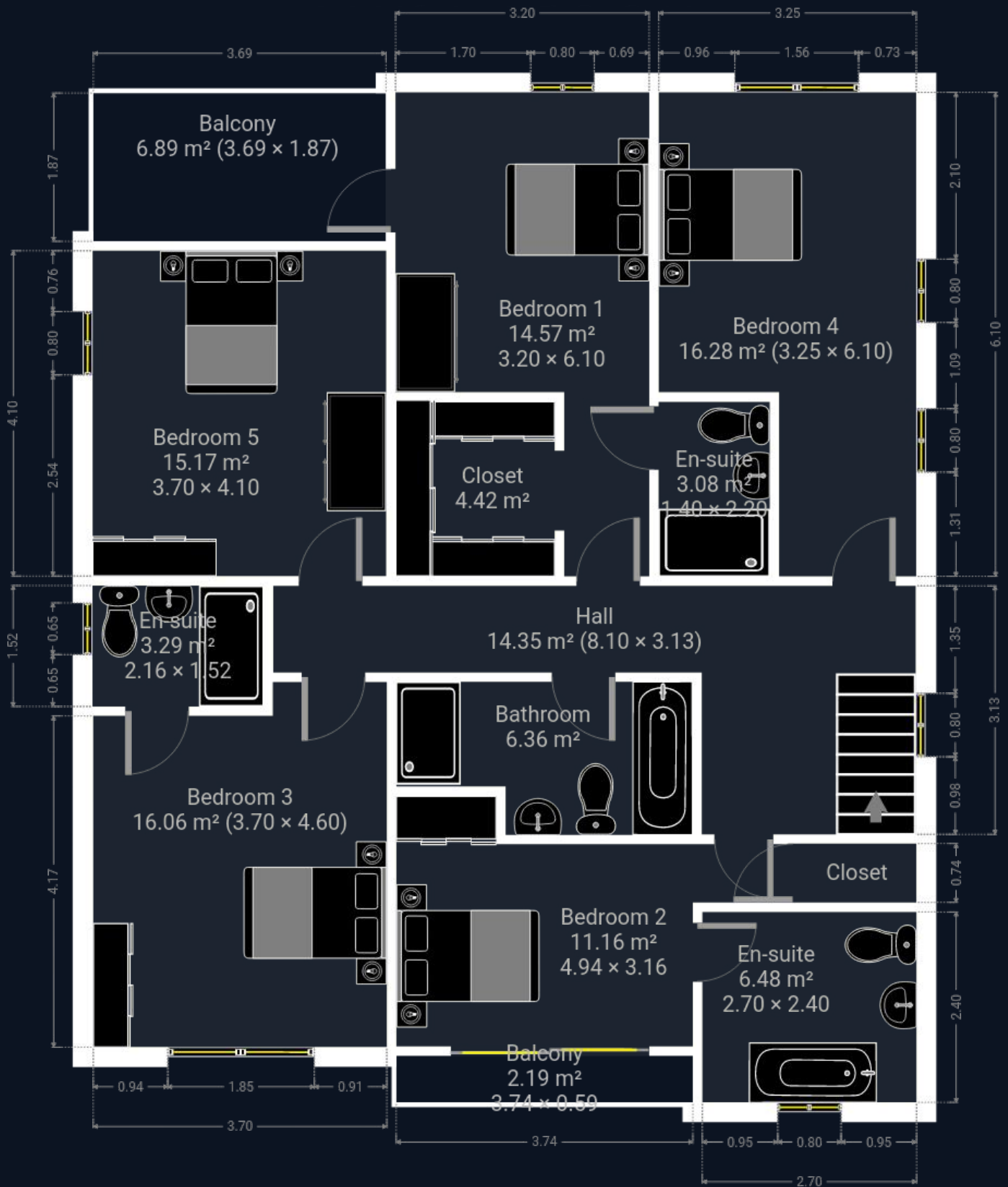

THE HOMES



B1 HOUSE TYPE 4 BEDROOM - PLOT 11, 12, 16 & 17
GUIDE PRICE £950,000

UNRIVALLED AND UNINTERRUPTED VIEWS, WHETHER IT BE BEAUTIFUL MORNING SUNRISES TO OUTSTANDING SUNSETS ON YOUR OWN PRIVATE BALCONY. WITH EXCEPTIONAL ENERGY EFFICIENCY, THESE HOUSES OFFER AN OUTSTANDING LIFESTYLE AND AN EXPERIENCE WHILST IMMERSSED IN MANICURED PARKLAND GARDENS

[B1 PROPERTY VIDEO - CLICK HERE](#)

THE HOW
EXCLUSIVE GREEN LIVING

B1

B1 HOUSE TYPE HOUSE SPECIFICATIONS

KITCHEN

- A CHOICE OF LEADING GERMAN HACKER KITCHEN UNIT AND DOORS.
 - BLANCO UNDERMOUNTS SUBLINE 480/320-U 2 BOWL UNDERMOUNT SINK, LH BOWL WHITE
 - QUOOKER OR SIMILAR HOT TAP
 - CAPLE APPLIANCES SENSE WINE CABINET
 - SIEMENS OR SIMILAR BUILT IN OVEN
 - SIEMENS OR SIMILAR BUILT IN COMBI MICROWAVE OVEN
 - SIEMENS OR SIMILAR BUILT IN DISHWASHER
 - SIEMENS OR SIMILAR BUILT IN FRIDGE
 - SIEMENS OR SIMILAR BUILT IN FREEZER
- FEATURE UNITS INCLUDE, PULL RECYCLING BINS AND CUTLERY DRAWER
- CHOICE OF 30MM QUARTZ WORKTOP

BATHROOMS AND EN-SUITE(S)

- HIGH QUALITY CONTEMPORARY BESPOKE WHITE SANITARY WARE
- WALL HUNG WC'S WITH SOFT CLOSERS
- THERMOSTATIC MIXERS TO ALL SHOWERS AND BATHS
- TOWEL RADIATORS IN ALL BATHROOMS
- PORCELAIN WALL AND FLOOR TILES TO ALL BATHROOMS
- FREE STANDING BATHS AND WALK IN SHOWERS

INTERNAL FINISHES

- WOOD GRAIN BESPOKE DOORS
- SATIN CHROME DOOR FURTHER
- HANDMADE AND PAINTED SKIRTINGS AND ARCHITRAVES
- INSULATED PLASTERBOARD AND SKIMMING THROUGHOUT
- BESPOKE WALNUT, GLASS AND STEEL (ANTHRACITE COLOUR) STAIRCASE AND BALUSTRADE
- VELFAC LOW PROFILE WINDOWS AND DOORS IN ANTHRACITE (EXTERNAL) AND WHITE (INTERNAL)

EXTERNAL FINISHES

- GRAVEL AND BLOCK PAVED DRIVEWAY
- INDIAN SANDSTONE PATIOS AND PATHS
- BLACK HAND-PAINTED SIBERIAN LARCH CLADDING AND BRICKWORK EXTERIOR FINISH
- HAND CRAFTED ZINC DORMER WINDOWS AND ALUMINIUM PORCH
- DETACHED DOUBLE GARAGE, BIKE STORE AND SHED WITH ELECTRIC ROLLER SHUTTER DOOR TO DOUBLE GARAGE (JUST FOR THE C1)

HEATING AND WATER SYSTEMS

- AIR-SOURCE HEAT PUMP CENTRAL HEATING SYSTEM
- OPTION TO ENABLE WIFI CONTROL THROUGHOUT
- UNDERFLOOR HEATING THROUGHOUT GROUND FLOOR
- COMPACT RADIATORS TO FIRST FLOOR WITH OPTION TO ENABLE WIFI CONTROL
- PRESSURED HOT WATER SYSTEM
- OUTSIDE TAP

ELECTRICAL

- MOTION ACTIVATED LIGHT SENSORS TO BATHROOMS
- LOW ENERGY LED DOWNLIGHTING THROUGHOUT (OPTION TO CONTROL THROUGH WIFI)
- OUTSIDE POWER POINTS
- EXTERNAL WALL LOW ENERGY LED LIGHTS TO FULL PERIMETER OF THE DWELLING AND GARAGE (DUSK TIL DAWN SENSOR)
- LANDSCAPED GARDEN LIGHTING (DUSK TIL DAWN SENSOR)

INTERNET AND TV

- CCTV WIRING THROUGHOUT
- FULLY WIRED FOR CRESTRON OR CONTROL 4 SYSTEM THROUGHOUT TO INCLUDE ALL TV AND SPEAKER POSITIONS
- CAT 6 AND HDMI OUTPUTS THROUGHOUT

B1 GREEN LIVING

Predicted Energy Assessment

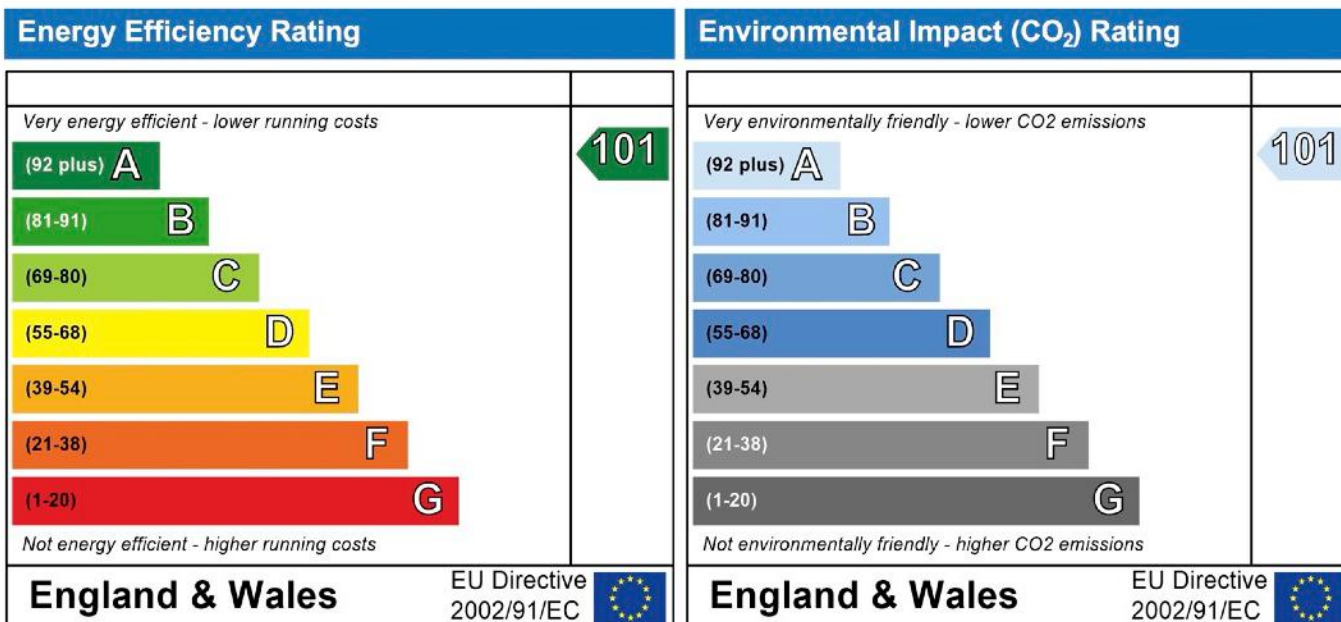

The energy efficiency rating is a measure of the overall efficiency of a home. The higher the rating the more energy efficient the home is and the lower the fuel bills are likely to be.

The environmental impact rating is a measure of a home's impact on the environment in terms of carbon dioxide (CO₂) emissions. The higher the rating the less impact it has on the environment.

Estimate Running Costs – B1

Item	Energy Usage	Cost per Unit	Total Cost
Space Heating	2128.37 kWh/year	20.43p/kWh	£434.83 per year
Water Heating	564.30 kWh/year	20.43p/kWh	£115.29 per year
Energy For Pumps and Fans	184.27 kWh/year	20.43p/kWh	£37.65 per year
Energy for Lighting	616.59 kWh/year	20.43p/kWh	£125.97 per year
TOTAL COST:			£713.74 per year

B1

GROUND FLOOR

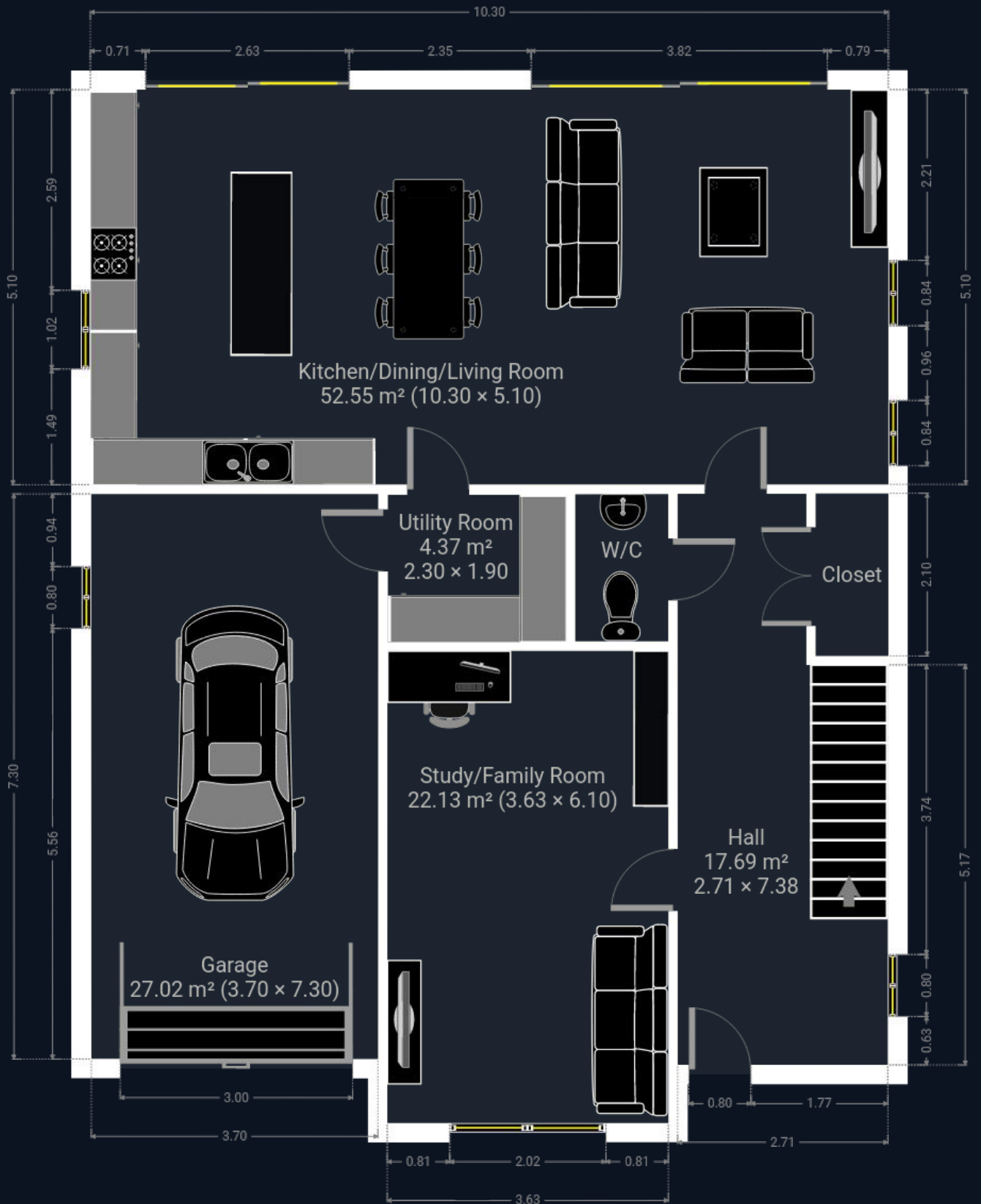

B1

FIRST FLOOR

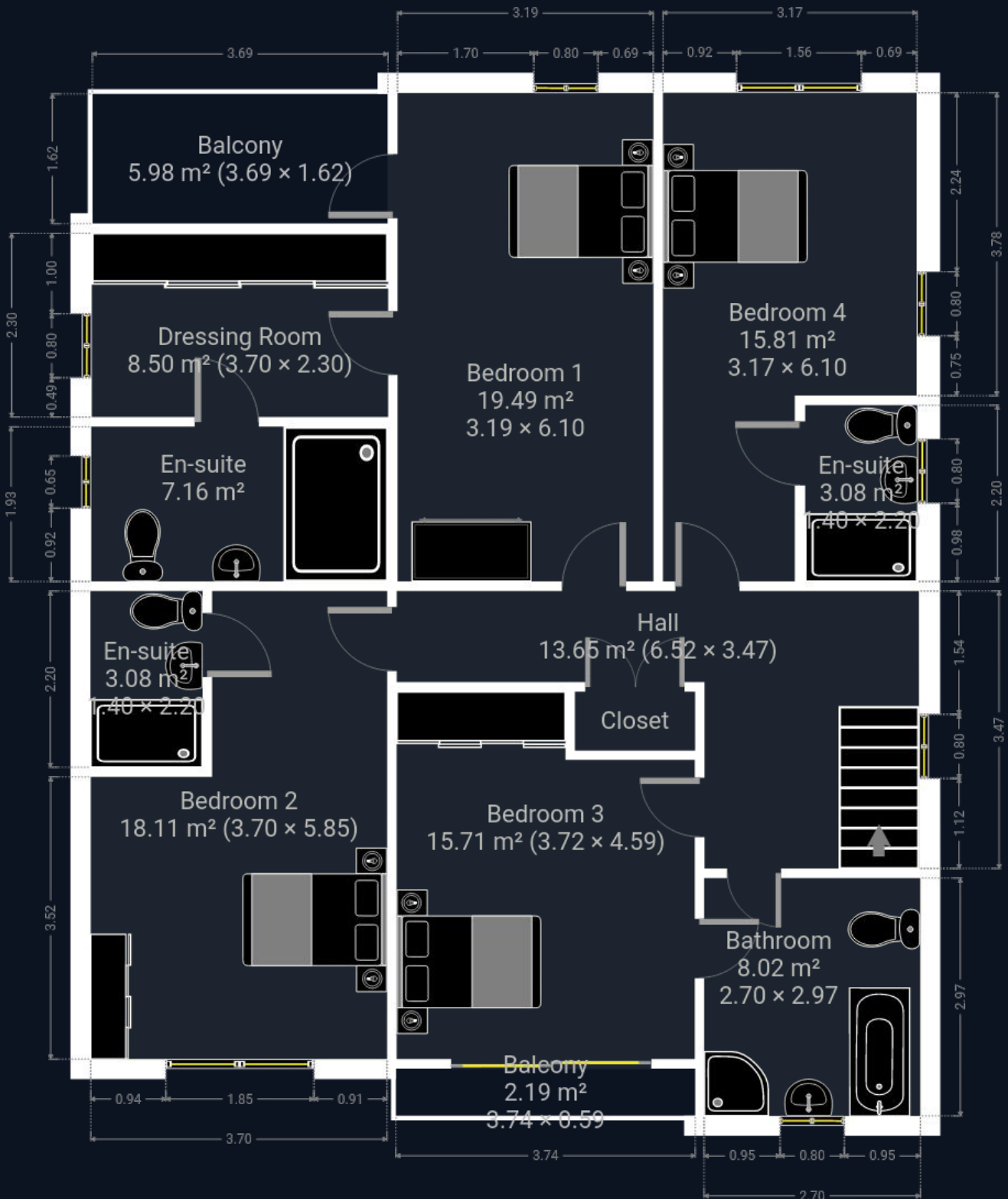

THE HOMES



A2 PLOT 7&8 GUIDE PRICE £350,000

SURROUNDED BY STUNNING COMMUNAL PARKLAND GARDENS, THE A-TYPE HOUSE TYPES AT THE HOW HAVE BEEN CREATED USING THE LATEST RENEWABLE ENERGY, INCLUDING AIR SOURCE HEAT PUMPS, SOLAR PANELS AND IMPROVED INSULATION THROUGHOUT AND BUILT TO UNPARALLELED STANDARD WITH BREATH-TAKING FINISHES AND SPECIFICATIONS OF THE HIGHEST QUALITY THROUGHOUT

THE HOW
EXCLUSIVE GREEN LIVING

A2

GROUND FLOOR

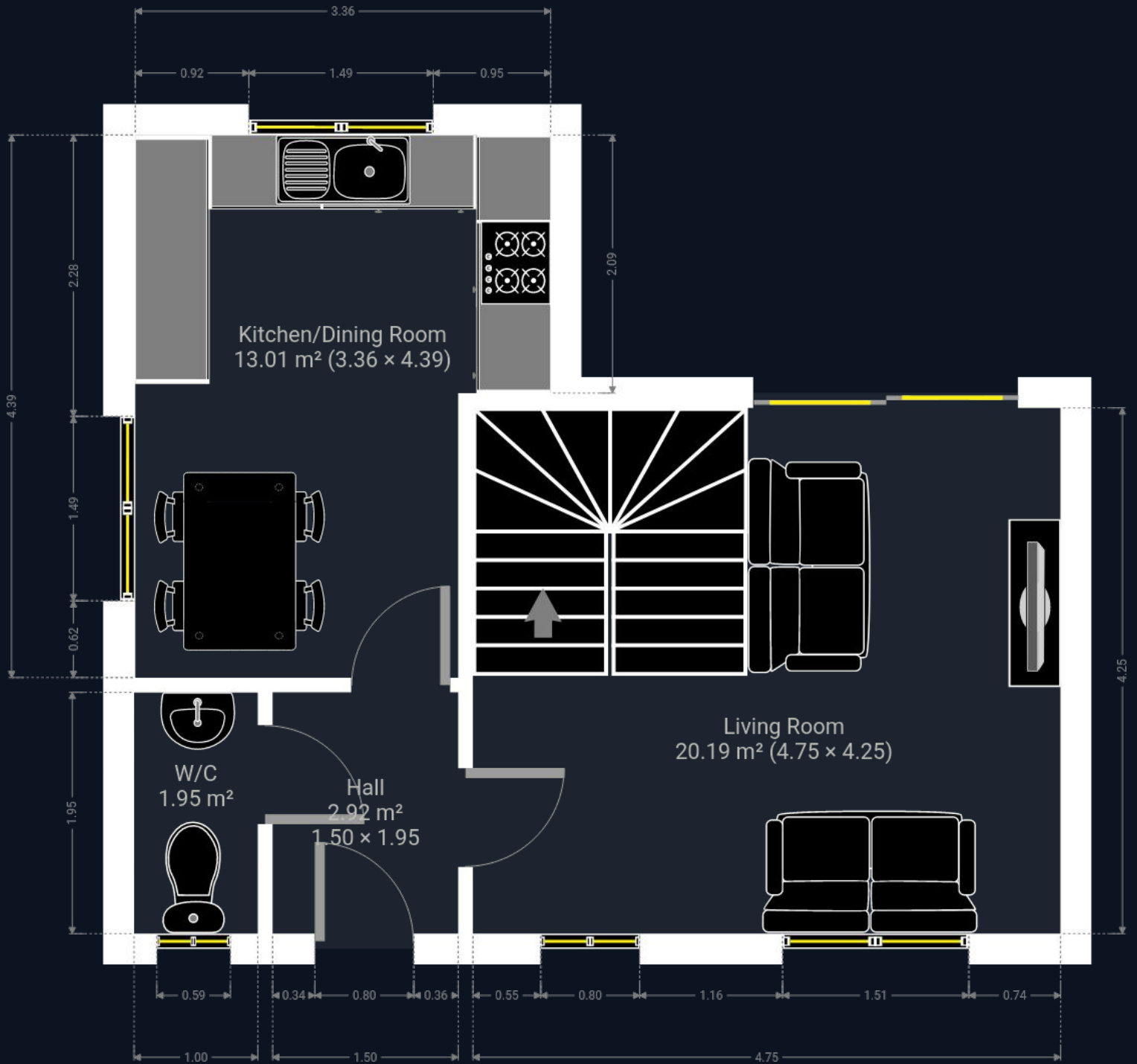

A2 FIRST FLOOR

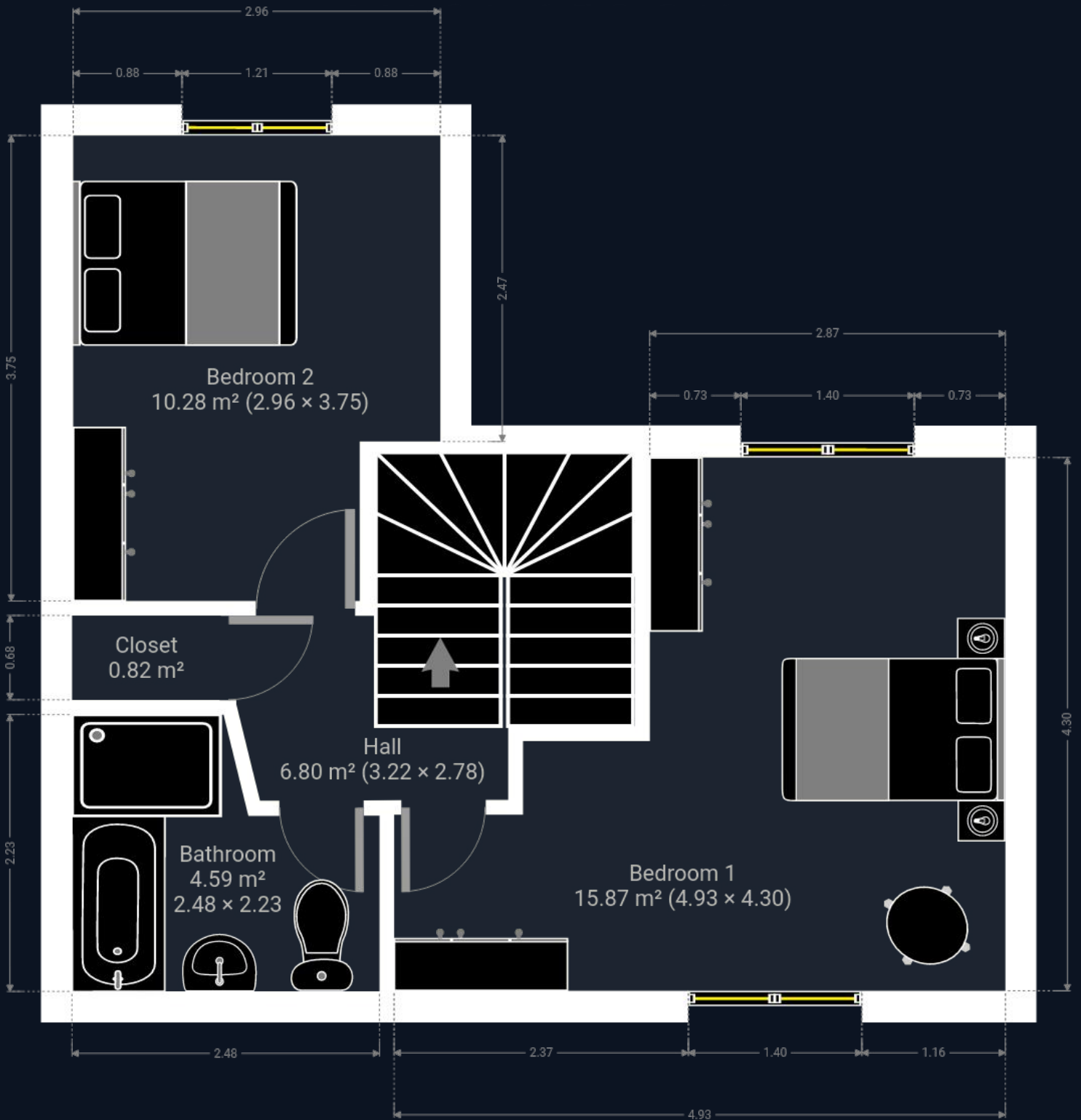

THE HOMES



A3 PLOT 6 GUIDE PRICE £400,000

SURROUNDED BY STUNNING COMMUNAL PARKLAND GARDENS, THE A-TYPE HOUSE TYPES AT THE HOW HAVE BEEN CREATED USING THE LATEST RENEWABLE ENERGY, INCLUDING AIR SOURCE HEAT PUMPS, SOLAR PANELS AND IMPROVED INSULATION THROUGHOUT AND BUILT TO UNPARALLELED STANDARD WITH BREATH-TAKING FINISHES AND SPECIFICATIONS OF THE HIGHEST QUALITY THROUGHOUT

THE HOW
EXCLUSIVE GREEN LIVING

A3

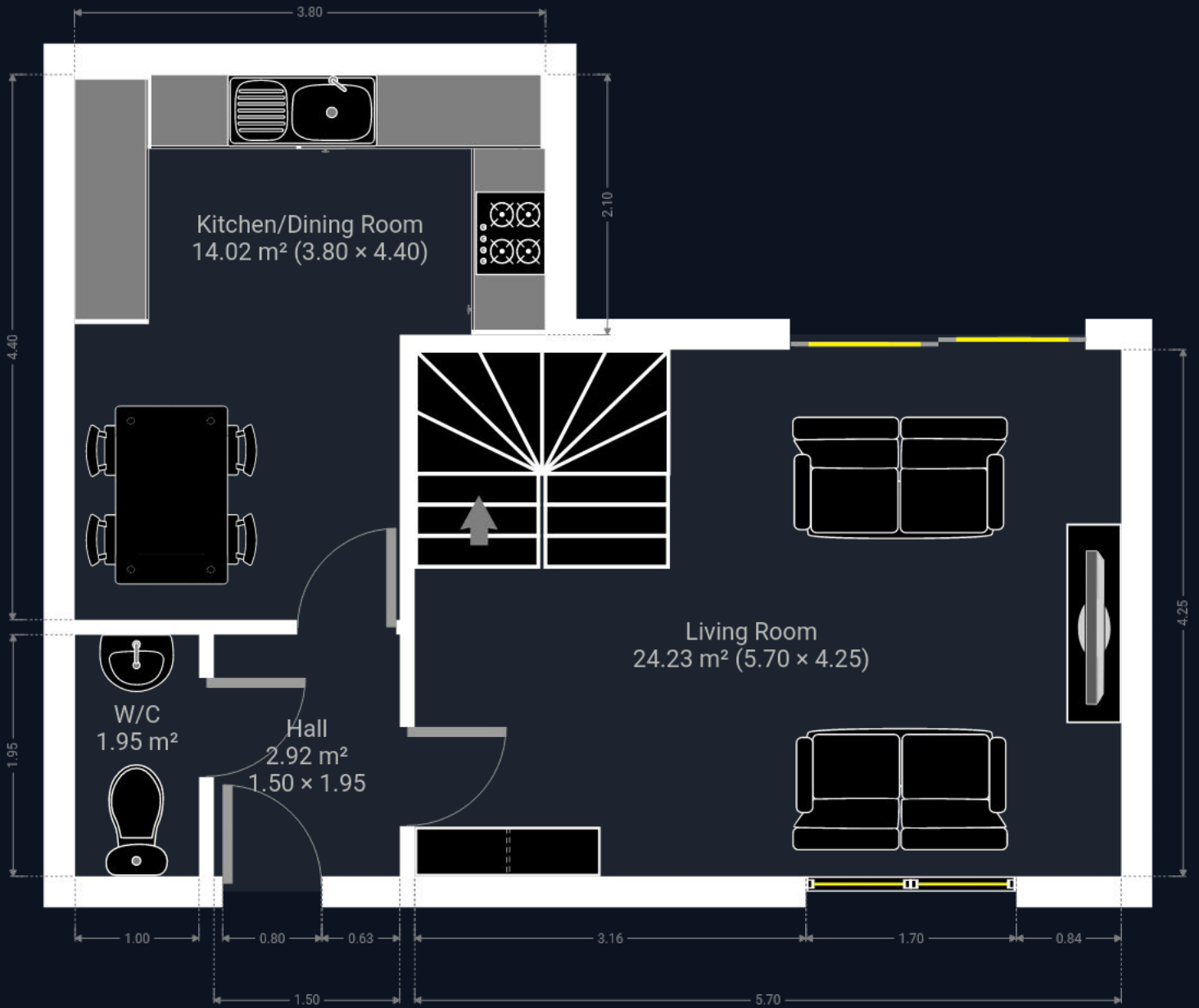

A3

FIRST FLOOR

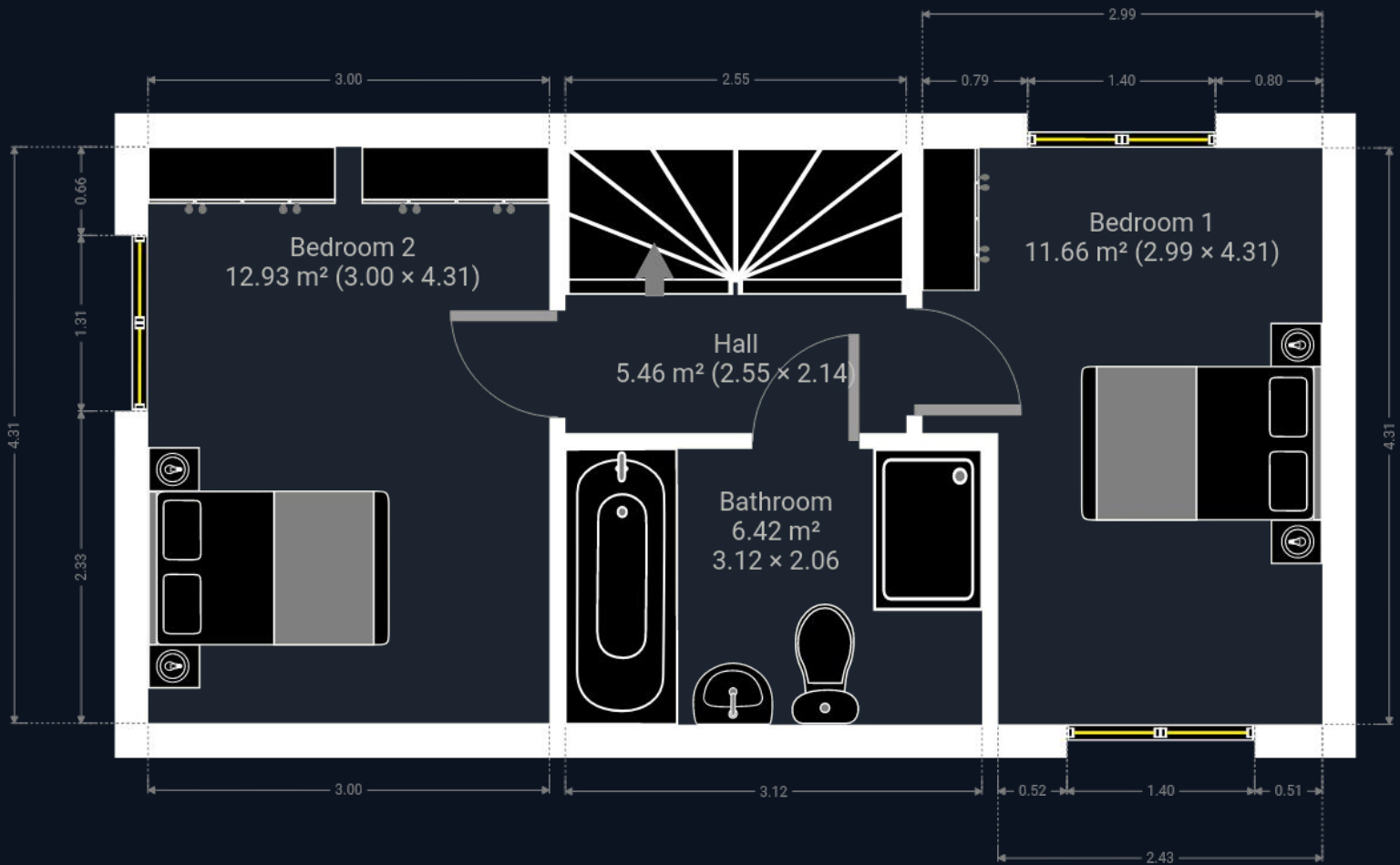

THE HOMES



A4 PLOT 9 GUIDE PRICE £500,000

SURROUNDED BY STUNNING COMMUNAL PARKLAND GARDENS, THE A-TYPE HOUSE TYPES AT THE HOW HAVE BEEN CREATED USING THE LATEST RENEWABLE ENERGY, INCLUDING AIR SOURCE HEAT PUMPS, SOLAR PANELS AND IMPROVED INSULATION THROUGHOUT AND BUILT TO UNPARALLELED STANDARD WITH BREATH-TAKING FINISHES AND SPECIFICATIONS OF THE HIGHEST QUALITY THROUGHOUT

THE HOW
EXCLUSIVE GREEN LIVING

A4

GROUND FLOOR

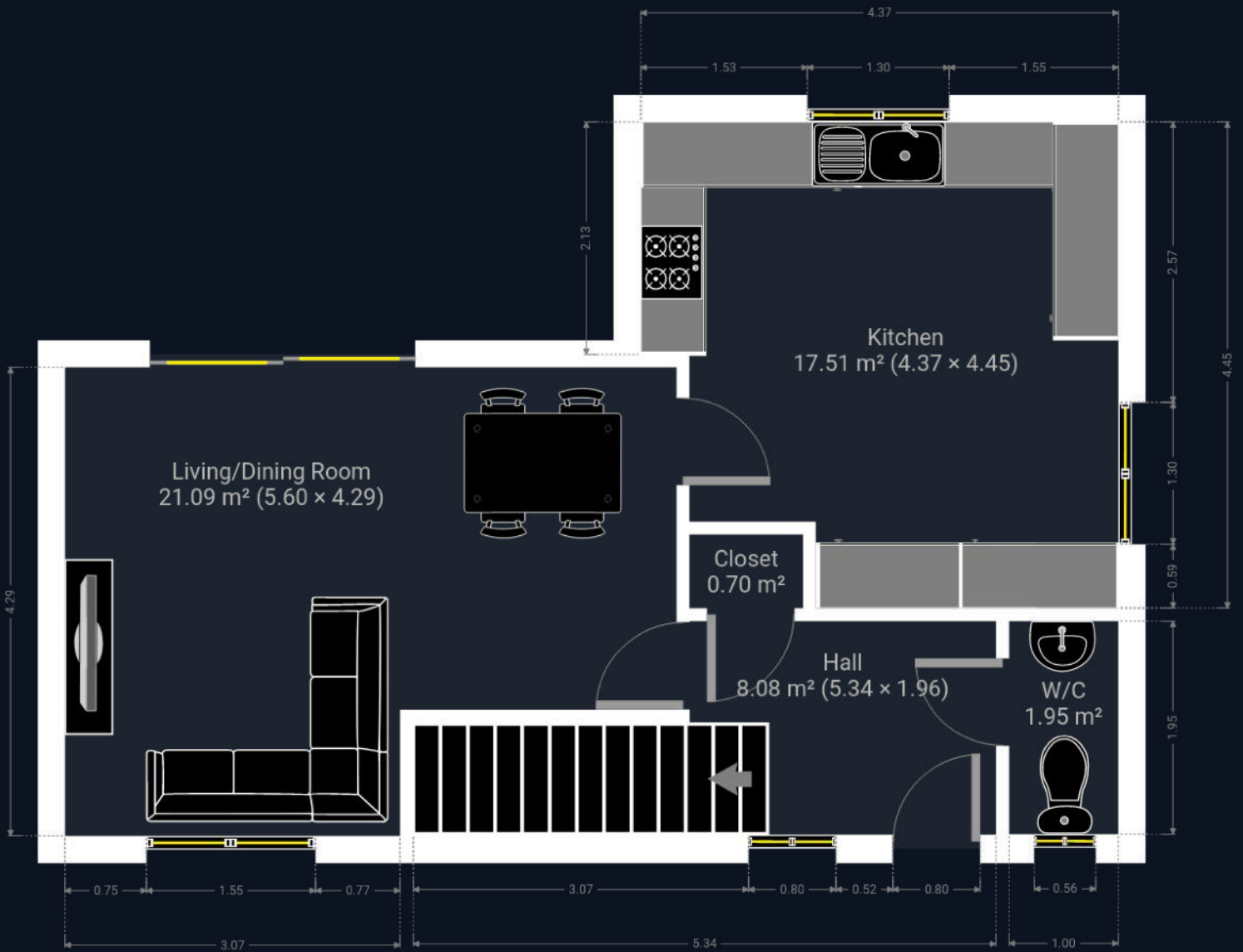

THE WESTERN GARDEN



WITH UNINTERRUPTED VIEWS OVERLOOKING THE CONSERVATION AREA TOWARDS HEMINGFORD CREATES AN UNRIVALLED ASPECT LIKE NO OTHER. EASY ACCESS THROUGH THE ORCHARD TO THE THICKET WOODLAND AND RIVER OUSE THROUGH THE RESIDENTS ONLY KEY CODED GATES. THE GATEWAYS ALSO TAKE YOU ONTO THE SCENIC FOOTPATH WHICH CAN LEAD TO ST IVES TOWN CENTRE, BURNHAM PARK AND HOUGHTON.

THE EASTERN GARDEN



PRIVATE GATED ACCESSED BY TREE LINED DRIVEWAY WITH PICTURESQUE VIEWS OVER ST IVES AND NEIGHBOURING VILLAGES SURROUNDED BY STUNNING PARKLAND AREA, THE EASTERN GARDEN IS CAMBRIDGESHIRE COUNTRYSIDE AT ITS FINEST. EASY ACCESS THROUGH THE ORCHARD TO THE THICKET WOODLAND AND RIVER OUSE THROUGH THE RESIDENTS ONLY KEY CODED GATES. THE GATEWAYS ALSO TAKE YOU ONTO THE SCENIC FOOTPATH WHICH CAN LEAD TO ST IVES TOWN CENTRE, BURNHAM PARK AND HOUGHTON.

THE SITE



THE HOW
EXCLUSIVE GREEN LIVING

LOCAL INFORMATION



ST IVES IS A CHARMING MARKET TOWN SET ON THE BANKS OF THE RIVER GREAT OUSE ABOUT 12 MILES TO THE NORTH-WEST OF CAMBRIDGE. THE MAIN STREET AND THE OLD QUAY, ON THE RIVERSIDE, HAVE MANY ATTRACTIVE BUILDINGS AND THERE ARE SEVERAL ARCHITECTURALLY IMPORTANT BUILDINGS SUCH AS THE JACOBAN MANOR HOUSE, 15TH CENTURY ALL SAINTS CHURCH AND THE SIX-ARCH BARNACK STONE BRIDGE WHICH INCORPORATES A CHAPEL - ONE OF ONLY FOUR OF ITS KIND LEFT IN ENGLAND. THE MARKET SQUARE HAS A GOOD RANGE OF SHOPS FROM NATIONAL CHAINS TO SMALL INDEPENDENT STORES.

THE WEEKLY MARKETS ARE A GREAT PLACE TO BUY LOCALLY PRODUCED FOODS, PLANTS AND GIFTS AND SEVERAL FOOD AND DRINK FESTIVALS AND CONTINENTAL MARKETS ARE HELD THROUGHOUT THE YEAR. THERE ARE PLENTY OF CHOICES FOR THE MORE ACTIVE WITH A LEISURE CENTRE, CHAMPIONSHIP GOLF CLUB AND AN ARRAY OF SPORTS CLUBS RANGING FROM BOWLS AND BOXING THROUGH TO RUGBY AND SAILING - SOMETHING FOR ALL AGES.

THE GUIDED BUSWAY IN ST IVES, THE LONGEST IN THE WORLD, RUNS THROUGH PRETTY COUNTRYSIDE AND PROVIDES QUICK AND FREQUENT ACCESS TO THE CENTRE OF CAMBRIDGE. CAMBRIDGE IS ALSO ONE OF ONLY 11 CITIES IN THE UK THAT HAVE BEEN DESIGNATED AS ONE OF THE UK'S "CYCLING CITIES" - AN AWARD THAT CAMBRIDGE RECEIVED IN 2008. PACKED FULL OF STUNNING ARCHITECTURE AND NATURE, CAMBRIDGE IS A BEAUTIFUL UNIVERSITY TOWN RENOWNED FOR ITS IMPACT ON HISTORY. THE TIGHTLY PACKED CITY CENTRE IS PERFECT FOR EXPLORING ANCIENT COLLEGES, COBBLED STREETS AND THE PICTURESQUE "BACKS" ALONGSIDE THE RIVER CAM.

A CITY THAT CELEBRATES QUINTESSENTIAL ENGLAND WITH PIONEERING SCIENTIFIC RESEARCH. WITH FAMOUS ALUMNI SUCH AS ISAAC NEWTON, CHARLES DARWIN AND PROFESSOR STEPHEN HAWKING, YOU'LL BE FOLLOWING IN SOME FAMOUS FOOTSTEPS. SEE THE COLLEGES WHERE THESE GREAT MINDS STUDIED AND BE INSPIRED BY THE SAME SURROUNDINGS WHICH CHANGED THE COURSE OF HISTORY.

LOCAL INFORMATION



CHECK OUT THE
LOCAL AREA



CHECK OUT THE
LOCAL SCHOOLS

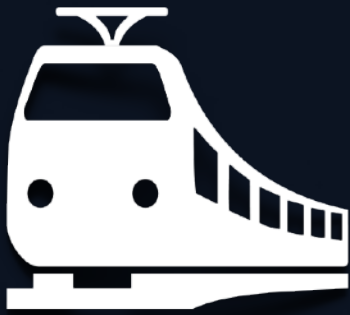

HUNTINGDON TRAIN
STATION LESS THAN 5 MILES
AWAY. LONDON KINGS CROSS
REACHABLE IN 48 MINUTES



A14 - 8.7 MILES
A1 - 8.7 MILES

LINKS & SOCIAL MEDIA



[CLICK HERE FOR ALL OUR VIDEOS ON THE HOW](#)



[CLICK HERE FOR OUR INSTAGRAM](#)



[CLICK HERE FOR OUR WEBSITE](#)