

# 9 Stratford Gardens

**SUBMITTED BY**

Ian  
ianhk@icloud.com

**CREATED ON**

2024-04-09

**LOCATION**

9 Stratford Gardens  
SS17 7AU Stanford-Le-Hope  
England  
United Kingdom

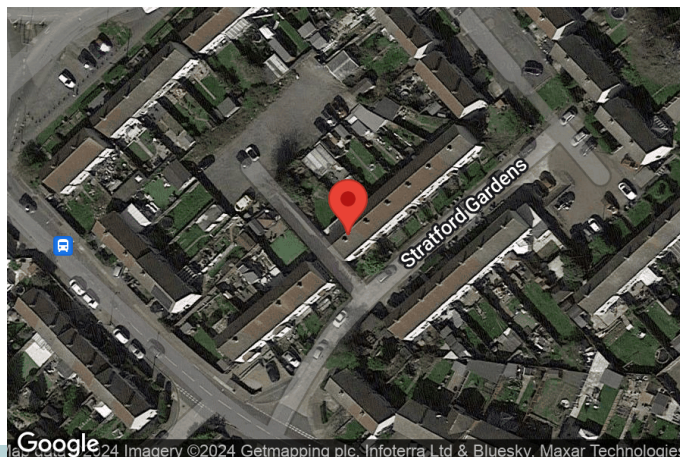

**Total area**  
1070.42 sq ft

**Floors**  
2

**Rooms**  
13

**Bathroom**  
1

**Photos**

2 Photos (see photos page)

**Kempsters**  
ESTATE AGENTS

## 9 Stratford Gardens

9 Stratford Gardens, SS17 7AU Stanford-Le-Hope, England, United Kingdom

TOTAL AREA: 1070.42 sq ft • LIVING AREA: 1070.42 sq ft • FLOORS: 2 • ROOMS: 13

**Kempsters**  
ESTATE AGENTS

### ▼ Photos/9 Stratford Gardens



**Kempsters**  
ESTATE AGENTS

# 9 Stratford Gardens

9 Stratford Gardens, SS17 7AU Stanford-Le-Hope, England, United Kingdom  
TOTAL AREA: 1070.42 sq ft • LIVING AREA: 1070.42 sq ft • FLOORS: 2 • ROOMS: 13



## ▼ Ground Floor

TOTAL AREA: 620.49 sq ft • LIVING AREA: 620.49 sq ft • ROOMS: 5

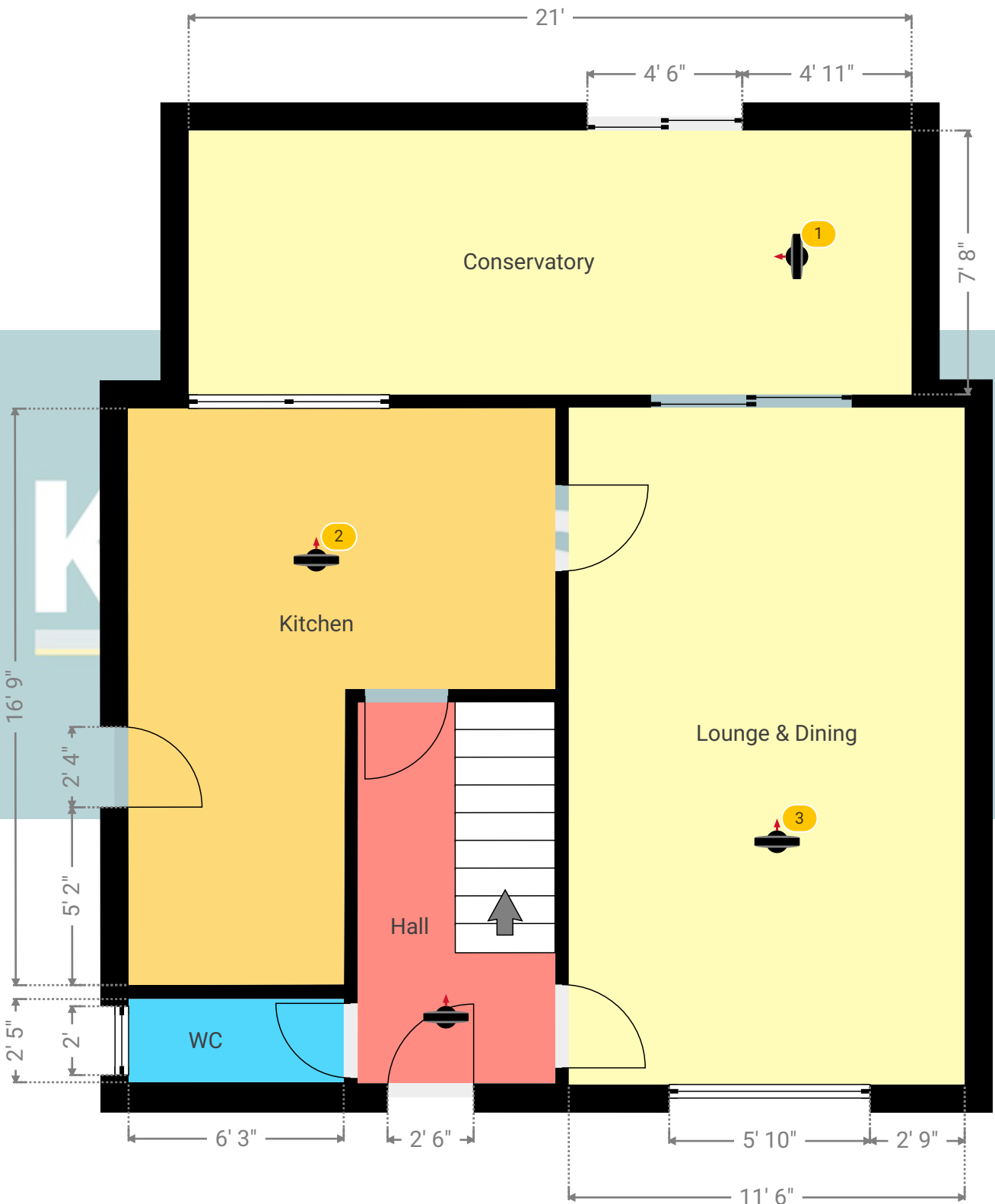

Kempsters Estate Agents take no responsibility for any error, omission, misstatement or use of data shown. This plan is for illustrative purposes only and whilst every attempt has been made to ensure the accuracy of the floorplan shown, all measurements, positioning, fixtures, fittings and any other data shown are an approximate interpretation for illustrative purposes only. These plans are the property of Kempsters Estate Agents Ltd and must not be reproduced in any form without our permission.

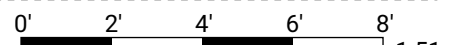

# 9 Stratford Gardens

9 Stratford Gardens, SS17 7AU Stanford-Le-Hope, England, United Kingdom  
TOTAL AREA: 1070.42 sq ft • LIVING AREA: 1070.42 sq ft • FLOORS: 2 • ROOMS: 13



## ▼ Conservatory Ground Floor

WIDTH: 21' • LENGTH: 7' 8"  
AREA: 161.01 sq ft • PERIMETER: 57' 4"

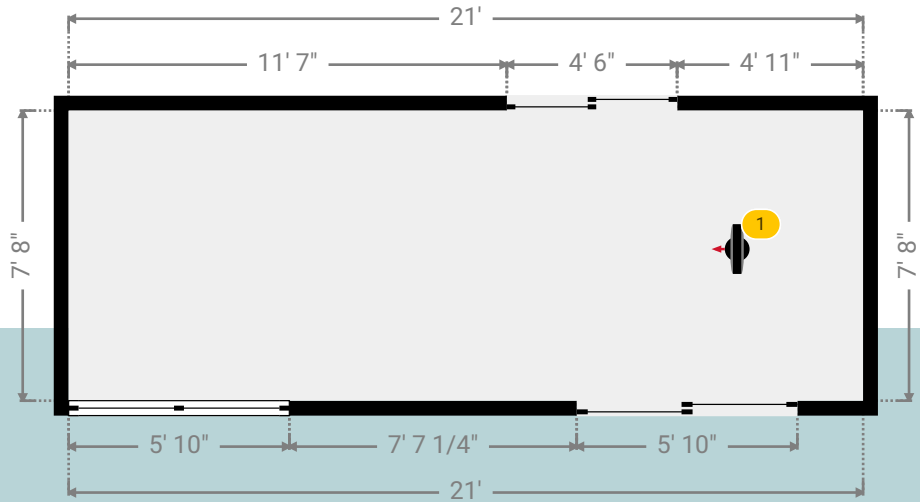
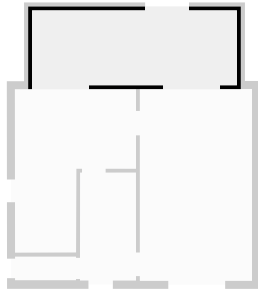

## ▼ Conservatory/Ground Floor

Photo  
1 Photo (see photos page)

### 1 360 PANORAMA

Photo  
1 Photo (see photos page)



## 9 Stratford Gardens

9 Stratford Gardens, SS17 7AU Stanford-Le-Hope, England, United Kingdom

TOTAL AREA: 1070.42 sq ft • LIVING AREA: 1070.42 sq ft • FLOORS: 2 • ROOMS: 13

**Kempsters**  
ESTATE AGENTS

### ▼ Photos/Conservatory

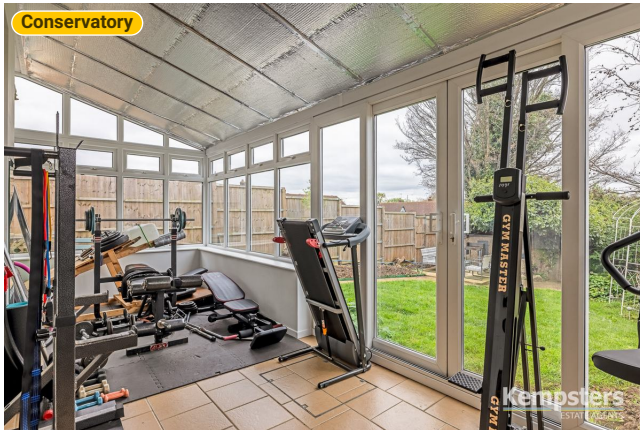

# Kempsters

ESTATE AGENTS

# 9 Stratford Gardens

9 Stratford Gardens, SS17 7AU Stanford-Le-Hope, England, United Kingdom  
TOTAL AREA: 1070.42 sq ft • LIVING AREA: 1070.42 sq ft • FLOORS: 2 • ROOMS: 13



## ▼ Hall Ground Floor

WIDTH: 5' 9" • LENGTH: 11' 3/4"  
AREA: 63.46 sq ft • PERIMETER: 33' 7 1/4"

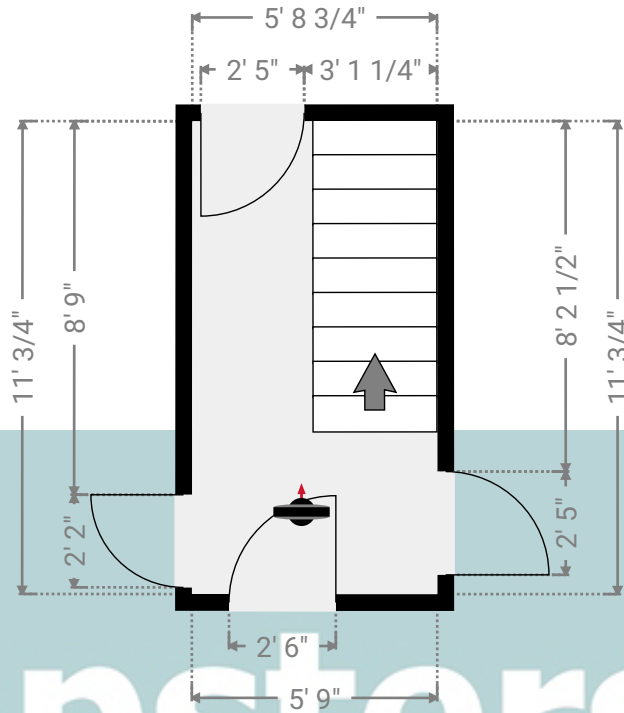
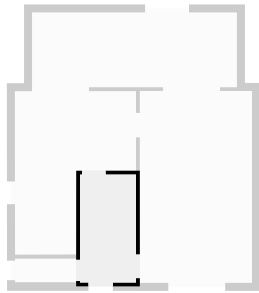

# Kempsters

ESTATE AGENTS

## ▼ Hall/Ground Floor

Photo  
1 Photo (see photos page)

## 9 Stratford Gardens

9 Stratford Gardens, SS17 7AU Stanford-Le-Hope, England, United Kingdom

TOTAL AREA: 1070.42 sq ft • LIVING AREA: 1070.42 sq ft • FLOORS: 2 • ROOMS: 13

**Kempsters**  
ESTATE AGENTS

### ▼ Photos/Hall



# Kempsters

ESTATE AGENTS

# 9 Stratford Gardens

9 Stratford Gardens, SS17 7AU Stanford-Le-Hope, England, United Kingdom  
TOTAL AREA: 1070.42 sq ft • LIVING AREA: 1070.42 sq ft • FLOORS: 2 • ROOMS: 13



## ▼ Kitchen Ground Floor

WIDTH: 12' 5" • LENGTH: 16' 9"  
AREA: 155.07 sq ft • PERIMETER: 58' 3 1/4"

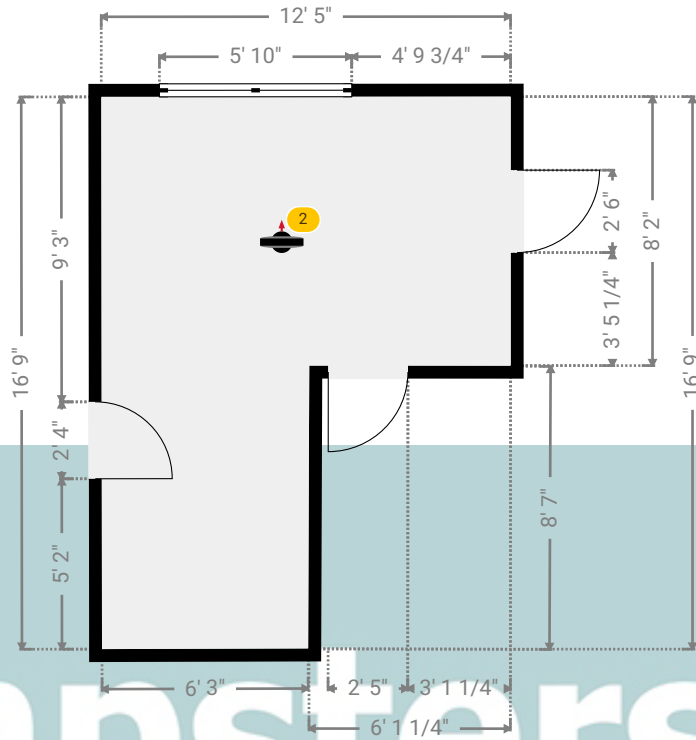
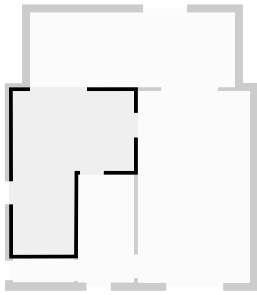

## ▼ Kitchen/Ground Floor

Photos  
6 Photos (see photos page)

### 2 360 PANORAMA

Photo  
1 Photo (see photos page)





# 9 Stratford Gardens

9 Stratford Gardens, SS17 7AU Stanford-Le-Hope, England, United Kingdom  
TOTAL AREA: 1070.42 sq ft • LIVING AREA: 1070.42 sq ft • FLOORS: 2 • ROOMS: 13



## ▼ Photos/Kitchen



Kempsters Estate Agents take no responsibility for any error, omission, misstatement or use of data shown. This plan is for illustrative purposes only and whilst every attempt has been made to ensure the accuracy of the floorplan shown, all measurements, positioning, fixtures, fittings and any other data shown are an approximate interpretation for illustrative purposes only. These plans are the property of Kempsters Estate Agents Ltd and must not be reproduced in any form without our permission.

# 9 Stratford Gardens

9 Stratford Gardens, SS17 7AU Stanford-Le-Hope, England, United Kingdom  
TOTAL AREA: 1070.42 sq ft • LIVING AREA: 1070.42 sq ft • FLOORS: 2 • ROOMS: 13



## ▼ Lounge & Dining Ground Floor

WIDTH: 11' 6" • LENGTH: 19' 8"  
AREA: 226.17 sq ft • PERIMETER: 62' 4"

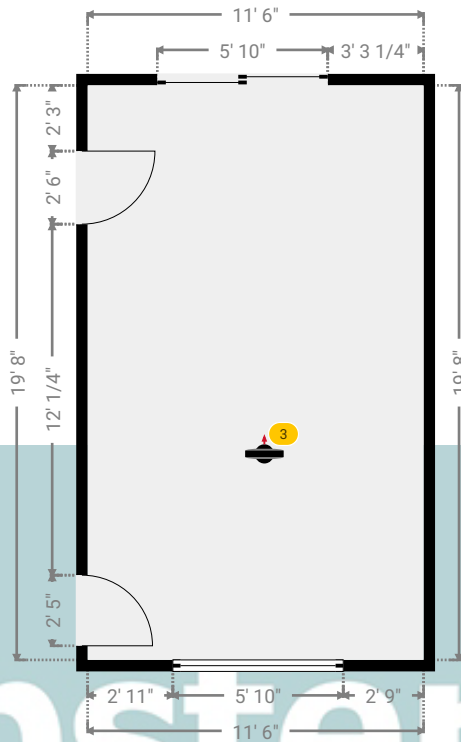
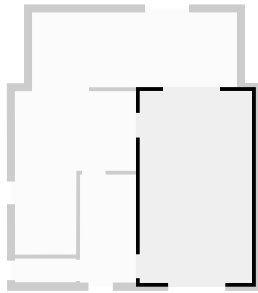

## ▼ Lounge & Dining/Ground Floor

Photo

1 Photo (see photos page)

### 3 360 PANORAMA

Photo

1 Photo (see photos page)



## 9 Stratford Gardens

9 Stratford Gardens, SS17 7AU Stanford-Le-Hope, England, United Kingdom

TOTAL AREA: 1070.42 sq ft • LIVING AREA: 1070.42 sq ft • FLOORS: 2 • ROOMS: 13

**Kempsters**  
ESTATE AGENTS

### ▼ Photos/Lounge & Dining



# Kempsters

ESTATE AGENTS

# 9 Stratford Gardens

9 Stratford Gardens, SS17 7AU Stanford-Le-Hope, England, United Kingdom  
TOTAL AREA: 1070.42 sq ft • LIVING AREA: 1070.42 sq ft • FLOORS: 2 • ROOMS: 13



## ▼ 1st Floor

TOTAL AREA: 449.93 sq ft • LIVING AREA: 449.93 sq ft • ROOMS: 8

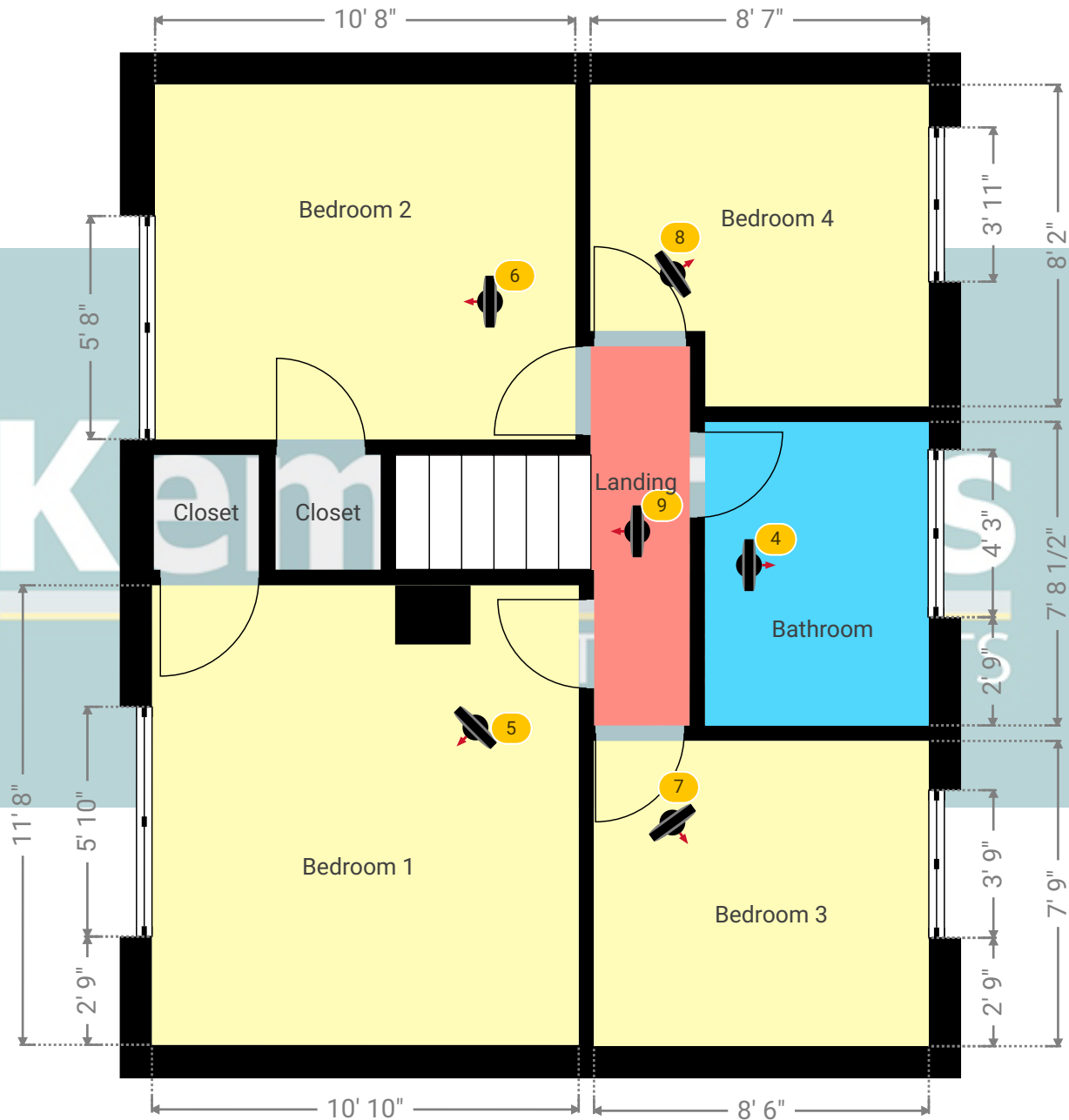

Kempsters Estate Agents take no responsibility for any error, omission, misstatement or use of data shown. This plan is for illustrative purposes only and whilst every attempt has been made to ensure the accuracy of the floorplan shown, all measurements, positioning, fixtures, fittings and any other data shown are an approximate interpretation for illustrative purposes only. These plans are the property of Kempsters Estate Agents Ltd and must not be reproduced in any form without our permission.

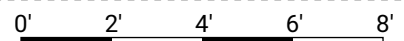

1:51

# 9 Stratford Gardens

9 Stratford Gardens, SS17 7AU Stanford-Le-Hope, England, United Kingdom  
TOTAL AREA: 1070.42 sq ft • LIVING AREA: 1070.42 sq ft • FLOORS: 2 • ROOMS: 13



## ▼ Bathroom 1st Floor

WIDTH: 7' 8 1/2" • LENGTH: 5' 8"  
AREA: 43.68 sq ft • PERIMETER: 26' 9"

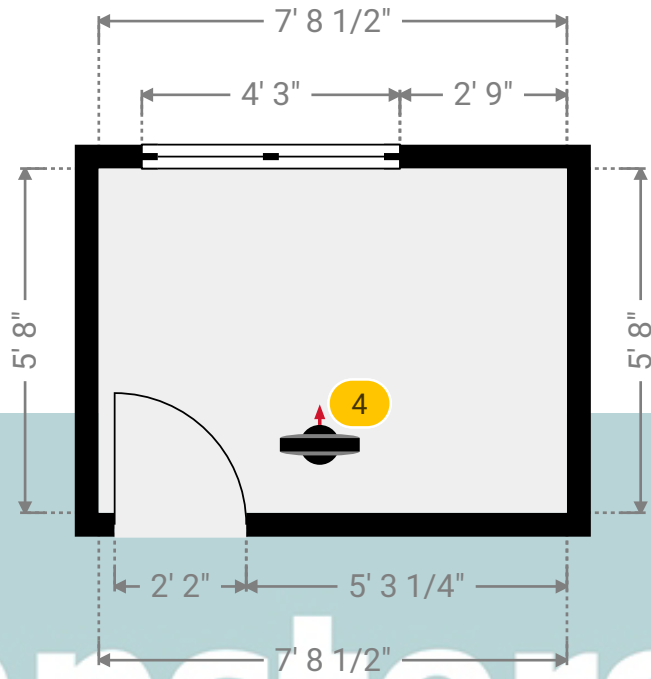
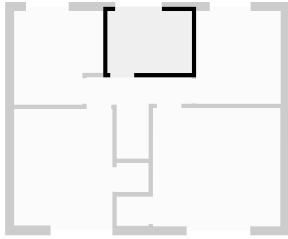

## ▼ Bathroom/1st Floor

Photos  
2 Photos (see photos page)

### 4 360 PANORAMA

Photo  
1 Photo (see photos page)



## 9 Stratford Gardens

9 Stratford Gardens, SS17 7AU Stanford-Le-Hope, England, United Kingdom

TOTAL AREA: 1070.42 sq ft • LIVING AREA: 1070.42 sq ft • FLOORS: 2 • ROOMS: 13

**Kempsters**  
ESTATE AGENTS

### ▼ Photos/Bathroom

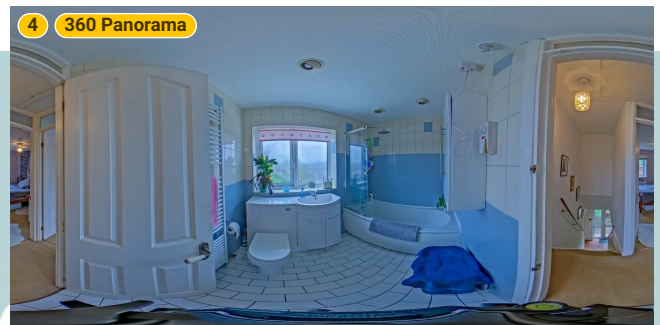

**Kempsters**  
ESTATE AGENTS

# 9 Stratford Gardens

9 Stratford Gardens, SS17 7AU Stanford-Le-Hope, England, United Kingdom  
TOTAL AREA: 1070.42 sq ft • LIVING AREA: 1070.42 sq ft • FLOORS: 2 • ROOMS: 13



## ▼ Bedroom 1 1st Floor

WIDTH: 11' 8" • LENGTH: 10' 10"  
AREA: 126.38 sq ft • PERIMETER: 45'

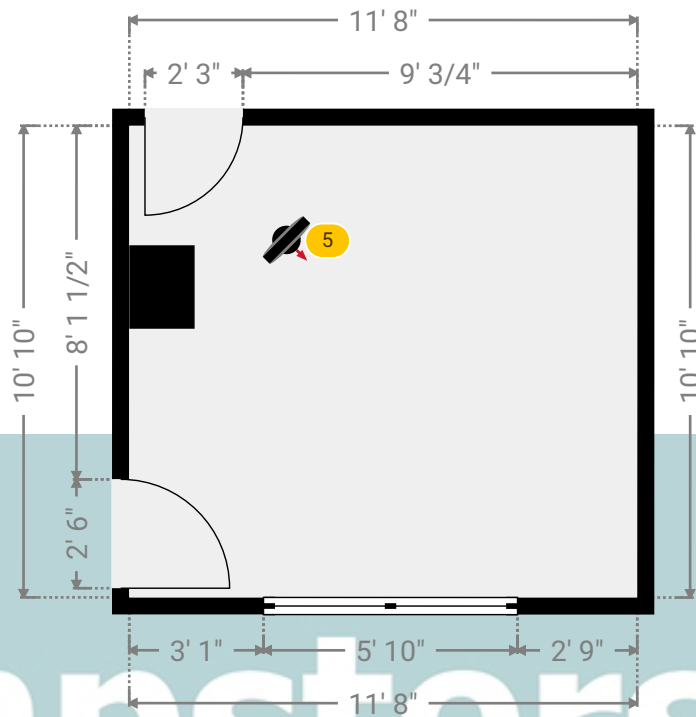
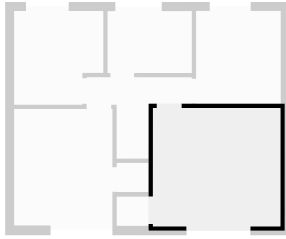

# Kempsters

ESTATE AGENTS

## ▼ Bedroom 1/1st Floor

Photos  
2 Photos (see photos page)

### 5 360 PANORAMA

Photo  
1 Photo (see photos page)



## 9 Stratford Gardens

9 Stratford Gardens, SS17 7AU Stanford-Le-Hope, England, United Kingdom

TOTAL AREA: 1070.42 sq ft • LIVING AREA: 1070.42 sq ft • FLOORS: 2 • ROOMS: 13

**Kempsters**  
ESTATE AGENTS

### ▼ Photos/Bedroom 1

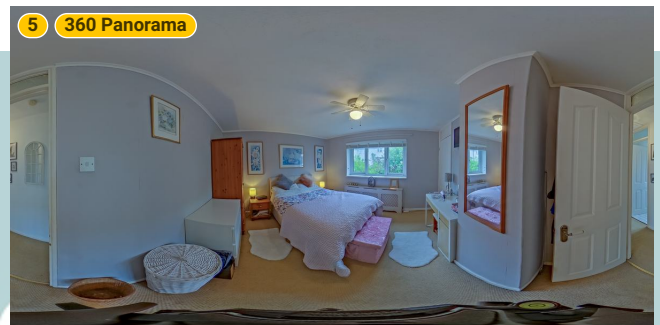
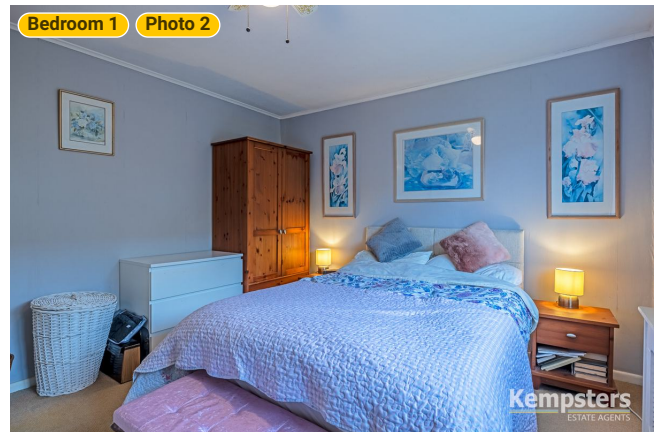
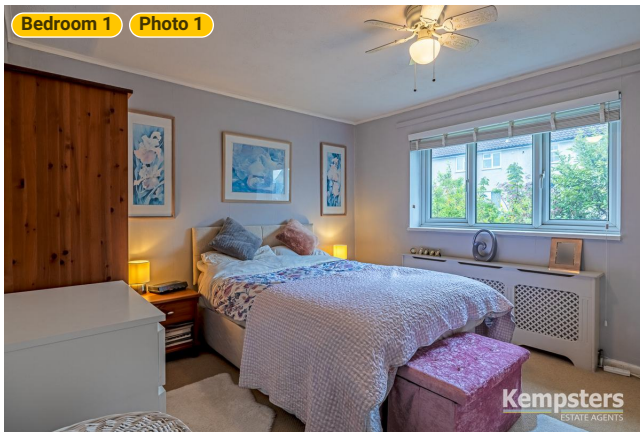

**Kempsters**  
ESTATE AGENTS



# 9 Stratford Gardens

9 Stratford Gardens, SS17 7AU Stanford-Le-Hope, England, United Kingdom  
TOTAL AREA: 1070.42 sq ft • LIVING AREA: 1070.42 sq ft • FLOORS: 2 • ROOMS: 13



## ▼ Bedroom 2 1st Floor

WIDTH: 9' • LENGTH: 10' 8"  
AREA: 96.00 sq ft • PERIMETER: 39' 4"

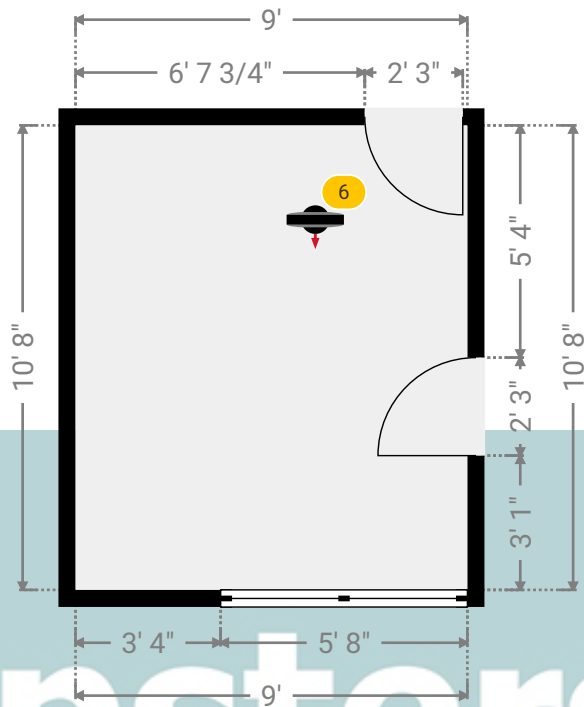
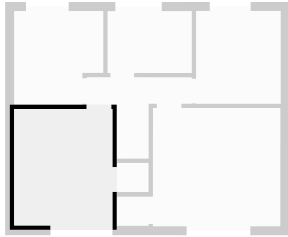

# Kempsters

ESTATE AGENTS

## ▼ Bedroom 2/1st Floor

Photo  
1 Photo (see photos page)

### 6 360 PANORAMA

Photo  
1 Photo (see photos page)



## 9 Stratford Gardens

9 Stratford Gardens, SS17 7AU Stanford-Le-Hope, England, United Kingdom

TOTAL AREA: 1070.42 sq ft • LIVING AREA: 1070.42 sq ft • FLOORS: 2 • ROOMS: 13

**Kempsters**  
ESTATE AGENTS

### ▼ Photos/Bedroom 2

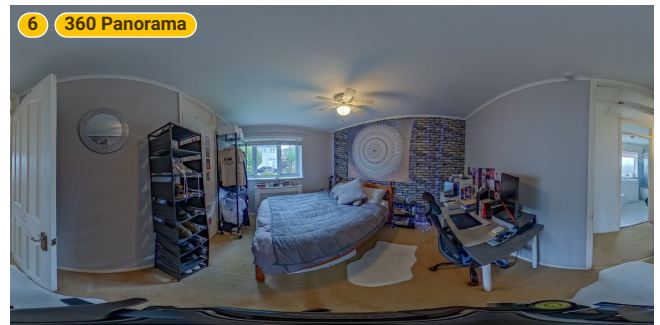
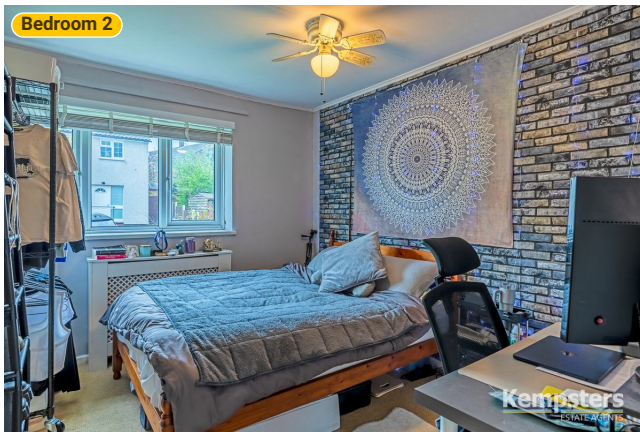

**Kempsters**  
ESTATE AGENTS

# 9 Stratford Gardens

9 Stratford Gardens, SS17 7AU Stanford-Le-Hope, England, United Kingdom  
TOTAL AREA: 1070.42 sq ft • LIVING AREA: 1070.42 sq ft • FLOORS: 2 • ROOMS: 13



## ▼ Bedroom 3 1st Floor

WIDTH: 7' 9" • LENGTH: 8' 6"  
AREA: 65.87 sq ft • PERIMETER: 32' 6"

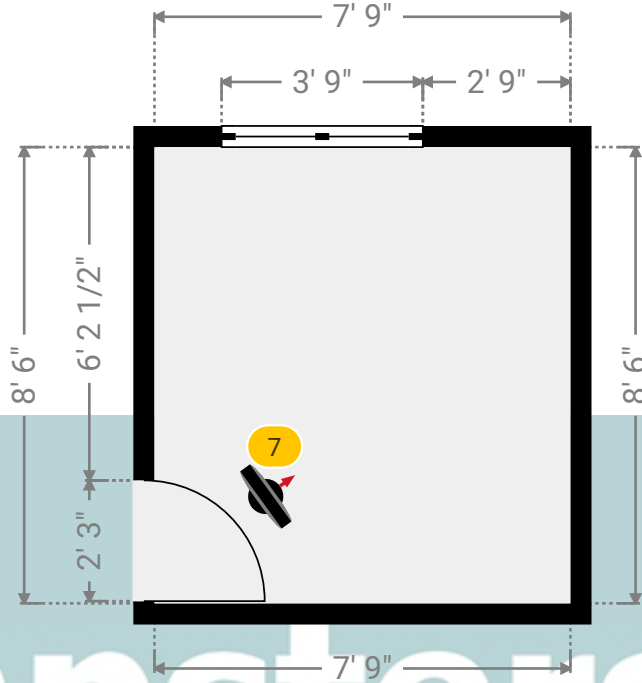
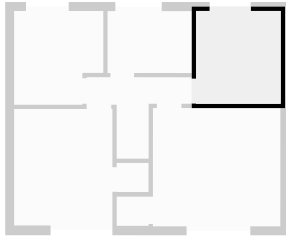

## ▼ Bedroom 3/1st Floor

Photo  
1 Photo (see photos page)

### 7 360 PANORAMA

Photo  
1 Photo (see photos page)



## 9 Stratford Gardens

9 Stratford Gardens, SS17 7AU Stanford-Le-Hope, England, United Kingdom

TOTAL AREA: 1070.42 sq ft • LIVING AREA: 1070.42 sq ft • FLOORS: 2 • ROOMS: 13

**Kempsters**  
ESTATE AGENTS

### ▼ Photos/Bedroom 3

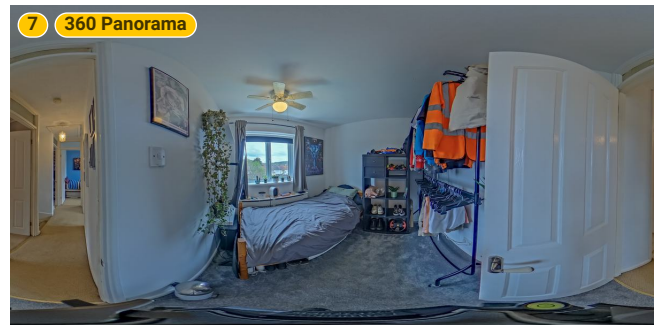

# Kempsters

ESTATE AGENTS

# 9 Stratford Gardens

9 Stratford Gardens, SS17 7AU Stanford-Le-Hope, England, United Kingdom  
TOTAL AREA: 1070.42 sq ft • LIVING AREA: 1070.42 sq ft • FLOORS: 2 • ROOMS: 13



## ▼ Bedroom 4 1st Floor

WIDTH: 8' 2" • LENGTH: 8' 7"  
AREA: 64.51 sq ft • PERIMETER: 33' 6"

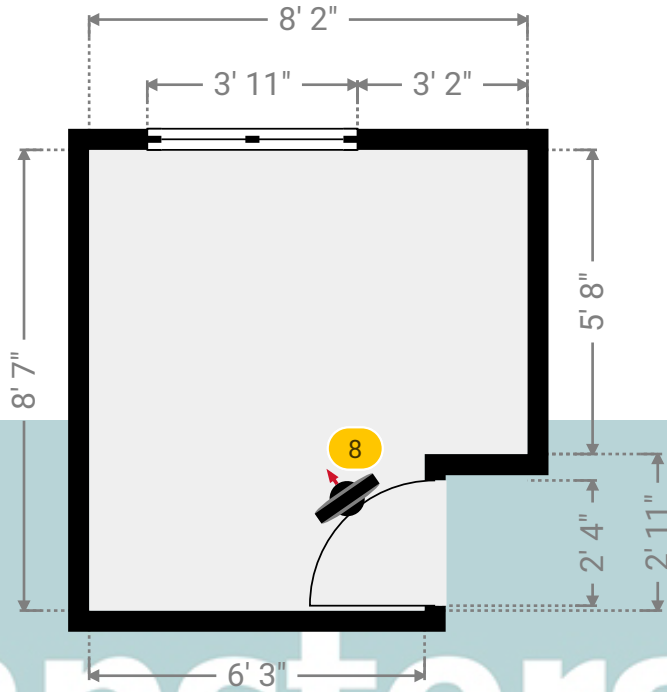
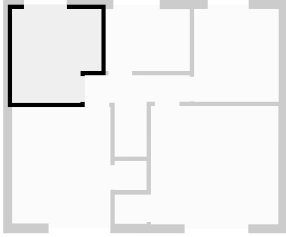

## ▼ Bedroom 4/1st Floor

Photo  
1 Photo (see photos page)

### 8 360 PANORAMA

Photo  
1 Photo (see photos page)



## 9 Stratford Gardens

9 Stratford Gardens, SS17 7AU Stanford-Le-Hope, England, United Kingdom

TOTAL AREA: 1070.42 sq ft • LIVING AREA: 1070.42 sq ft • FLOORS: 2 • ROOMS: 13

**Kempsters**  
ESTATE AGENTS

### ▼ Photos/Bedroom 4

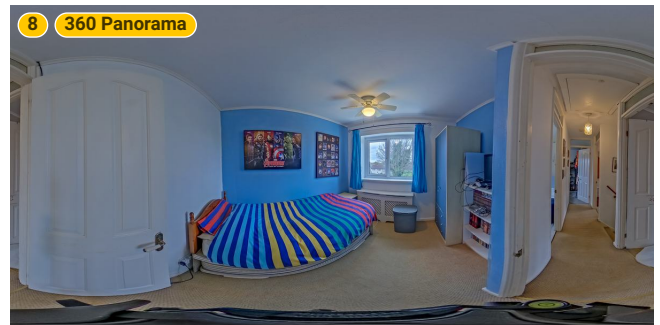

**Kempsters**  
ESTATE AGENTS

# 9 Stratford Gardens

9 Stratford Gardens, SS17 7AU Stanford-Le-Hope, England, United Kingdom  
TOTAL AREA: 1070.42 sq ft • LIVING AREA: 1070.42 sq ft • FLOORS: 2 • ROOMS: 13



## ▼ Landing 1st Floor

WIDTH: 9' 7 1/2" • LENGTH: 7' 5 1/2"  
AREA: 38.28 sq ft • PERIMETER: 34' 1 3/4"

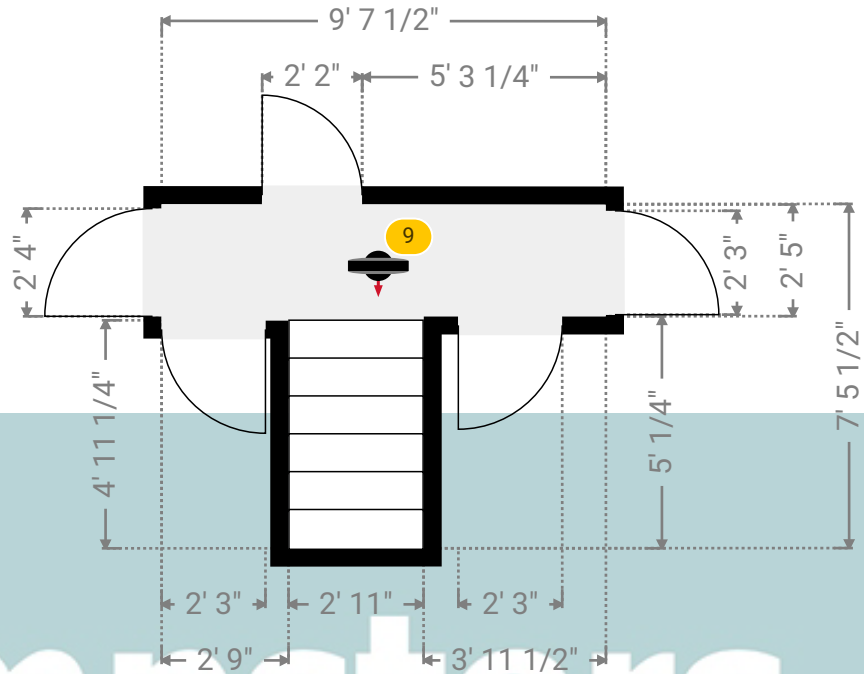
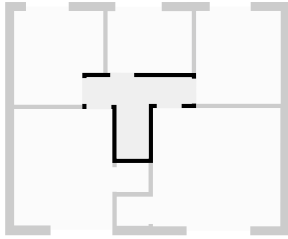

## ▼ Landing/1st Floor

Photo  
1 Photo (see photos page)

### 9 360 PANORAMA

Photo  
1 Photo (see photos page)



## 9 Stratford Gardens

9 Stratford Gardens, SS17 7AU Stanford-Le-Hope, England, United Kingdom

TOTAL AREA: 1070.42 sq ft • LIVING AREA: 1070.42 sq ft • FLOORS: 2 • ROOMS: 13

**Kempsters**  
ESTATE AGENTS

### ▼ Photos/Landing



**Kempsters**  
ESTATE AGENTS