

# 18 Sycamore Way

**SUBMITTED BY**

Ian  
ianhk@icloud.com

**CREATED ON**

2024-04-04

**LOCATION**

18 Sycamore Way  
RM15 6XB South Ockendon  
England  
United Kingdom



**Total area**  
916.12 sq ft

**Floors**  
2

**Rooms**  
12

**Bathrooms**  
2

# Kempsters

ESTATE AGENTS

# 18 Sycamore Way

18 Sycamore Way, RM15 6XB South Ockendon, England, United Kingdom  
TOTAL AREA: 916.12 sq ft • LIVING AREA: 916.12 sq ft • FLOORS: 2 • ROOMS: 12



## ▼ Ground Floor

TOTAL AREA: 589.87 sq ft • LIVING AREA: 589.87 sq ft • ROOMS: 7



Kempsters Estate Agents take no responsibility for any error, omission, misstatement or use of data shown. This plan is for illustrative purposes only and whilst every attempt has been made to ensure the accuracy of the floorplan shown, all measurements, positioning, fixtures, fittings and any other data shown are an approximate interpretation for illustrative purposes only. These plans are the property of Kempsters Estate Agents Ltd and must not be reproduced in any form without our permission.

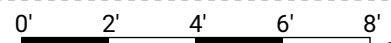

1:53

# 18 Sycamore Way

18 Sycamore Way, RM15 6XB South Ockendon, England, United Kingdom  
TOTAL AREA: 916.12 sq ft • LIVING AREA: 916.12 sq ft • FLOORS: 2 • ROOMS: 12



## ▼ Conservatory Ground Floor

WIDTH: 13' 5" • LENGTH: 8' 6"  
AREA: 114.03 sq ft • PERIMETER: 43' 10"

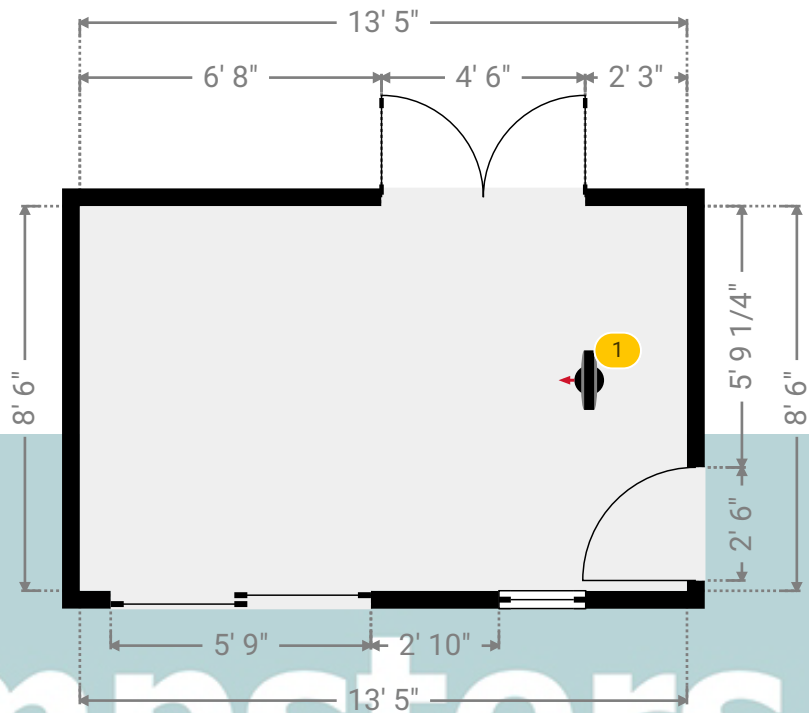
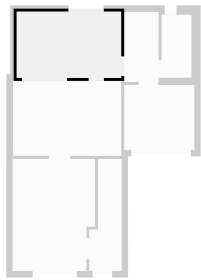

## ▼ Conservatory/Ground Floor

Photos  
3 Photos (see photos page)

### 1 360 PANORAMA

Photo  
1 Photo (see photos page)



# 18 Sycamore Way

18 Sycamore Way, RM15 6XB South Ockendon, England, United Kingdom  
TOTAL AREA: 916.12 sq ft • LIVING AREA: 916.12 sq ft • FLOORS: 2 • ROOMS: 12



## ▼ Photos/Conservatory



**Kempsters**  
ESTATE AGENTS

# 18 Sycamore Way

18 Sycamore Way, RM15 6XB South Ockendon, England, United Kingdom  
TOTAL AREA: 916.12 sq ft • LIVING AREA: 916.12 sq ft • FLOORS: 2 • ROOMS: 12



## ▼ Hall Ground Floor

WIDTH: 4' 2" • LENGTH: 14' 5 1/4"  
AREA: 49.70 sq ft • PERIMETER: 37' 2 1/4"

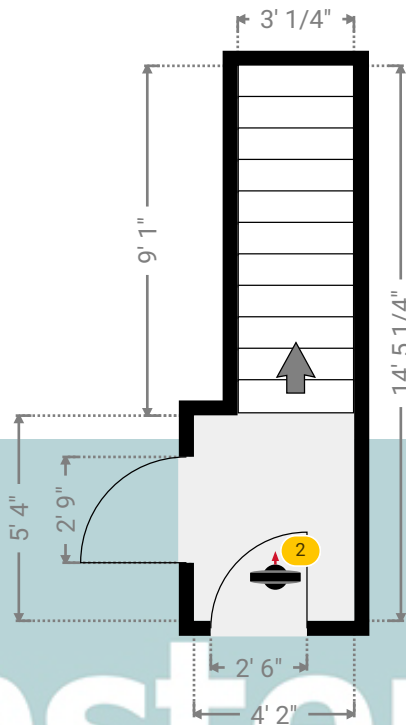
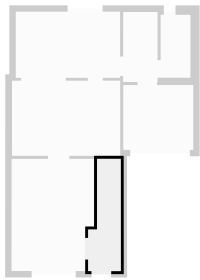

# Kempsters

ESTATE AGENTS

## ▼ Hall/Ground Floor

**Photos**  
2 Photos (see photos page)

### 2 360 PANORAMA

**Photo**  
1 Photo (see photos page)



# 18 Sycamore Way

18 Sycamore Way, RM15 6XB South Ockendon, England, United Kingdom  
TOTAL AREA: 916.12 sq ft • LIVING AREA: 916.12 sq ft • FLOORS: 2 • ROOMS: 12



## ▼ Photos/Hall

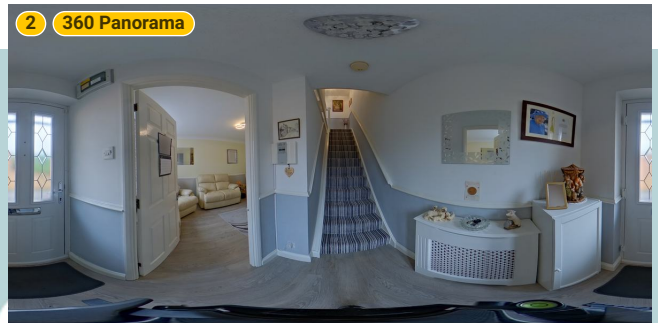
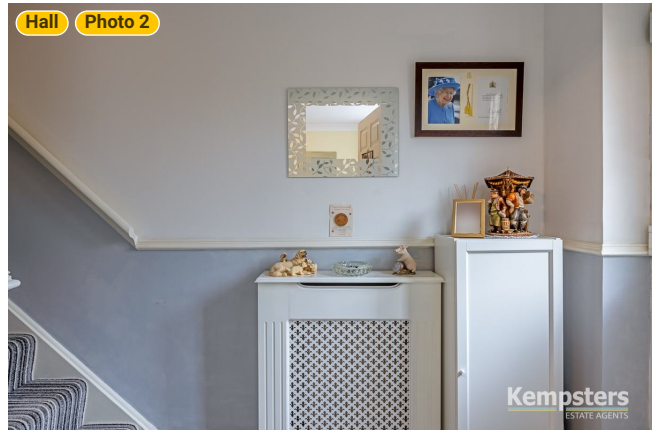

**Kempsters**  
ESTATE AGENTS

# 18 Sycamore Way

18 Sycamore Way, RM15 6XB South Ockendon, England, United Kingdom  
TOTAL AREA: 916.12 sq ft • LIVING AREA: 916.12 sq ft • FLOORS: 2 • ROOMS: 12



## ▼ Kitchen Ground Floor

WIDTH: 13' 11" • LENGTH: 9' 8"  
AREA: 134.41 sq ft • PERIMETER: 47' 1 3/4"

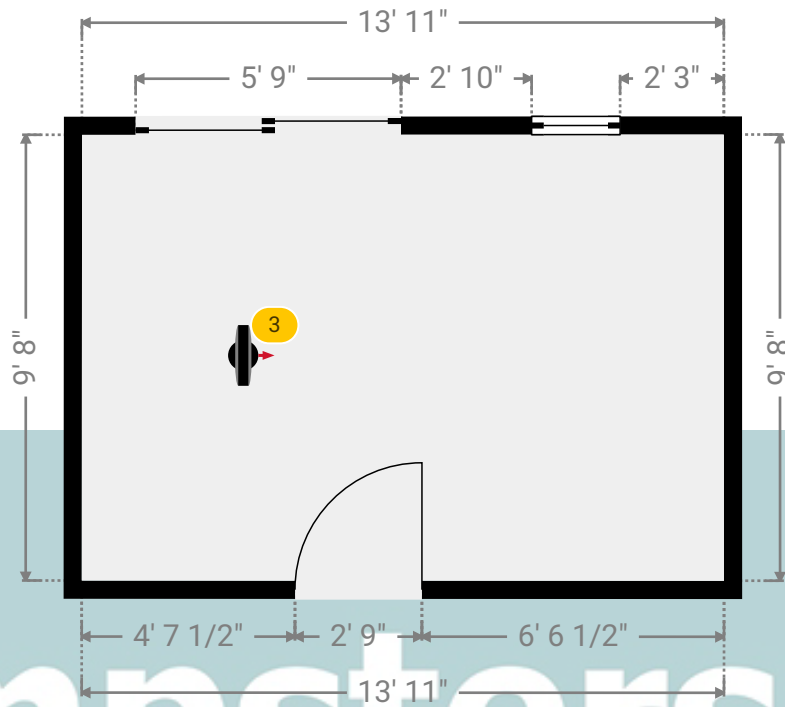
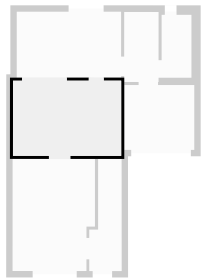

## ▼ Kitchen/Ground Floor

Photos  
5 Photos (see photos page)

### 3 360 PANORAMA

Photo  
1 Photo (see photos page)

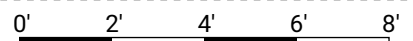

# 18 Sycamore Way

18 Sycamore Way, RM15 6XB South Ockendon, England, United Kingdom  
TOTAL AREA: 916.12 sq ft • LIVING AREA: 916.12 sq ft • FLOORS: 2 • ROOMS: 12

## ▼ Photos/Kitchen

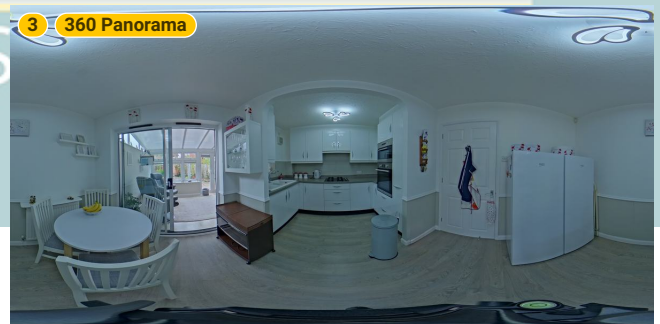
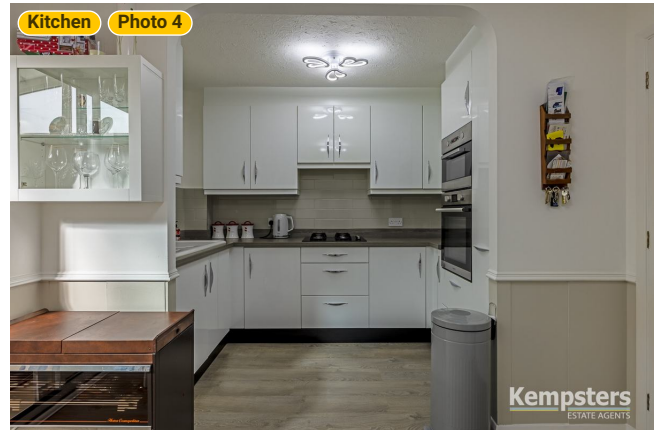



# 18 Sycamore Way

18 Sycamore Way, RM15 6XB South Ockendon, England, United Kingdom  
TOTAL AREA: 916.12 sq ft • LIVING AREA: 916.12 sq ft • FLOORS: 2 • ROOMS: 12



## ▼ Lounge Ground Floor

WIDTH: 10' 7" • LENGTH: 14' 5"  
AREA: 146.42 sq ft • PERIMETER: 50' 1/4"

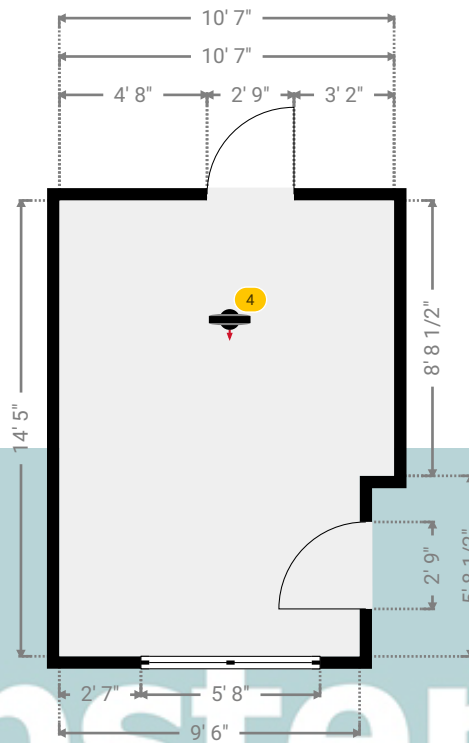
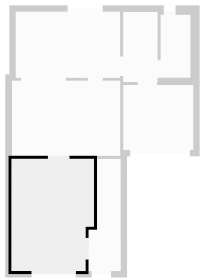

## ▼ Lounge/Ground Floor

Photos  
4 Photos (see photos page)

### 4 360 PANORAMA

Photo  
1 Photo (see photos page)



# 18 Sycamore Way

18 Sycamore Way, RM15 6XB South Ockendon, England, United Kingdom  
TOTAL AREA: 916.12 sq ft • LIVING AREA: 916.12 sq ft • FLOORS: 2 • ROOMS: 12



## ▼ Photos/Lounge

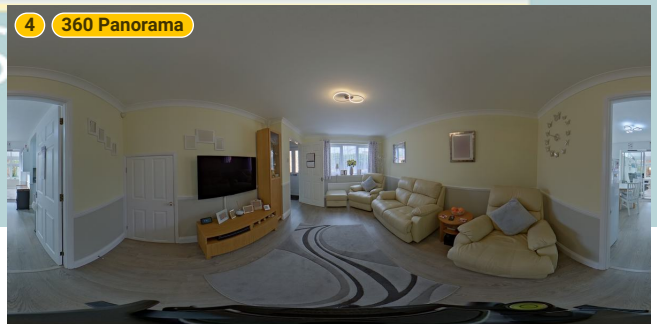
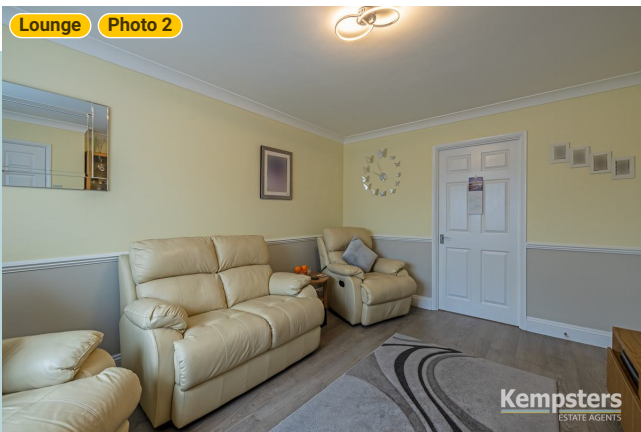

# 18 Sycamore Way

18 Sycamore Way, RM15 6XB South Ockendon, England, United Kingdom  
TOTAL AREA: 916.12 sq ft • LIVING AREA: 916.12 sq ft • FLOORS: 2 • ROOMS: 12



## ▼ Shower Ground Floor

WIDTH: 3' 10" • LENGTH: 8' 1"  
AREA: 30.99 sq ft • PERIMETER: 23' 10"

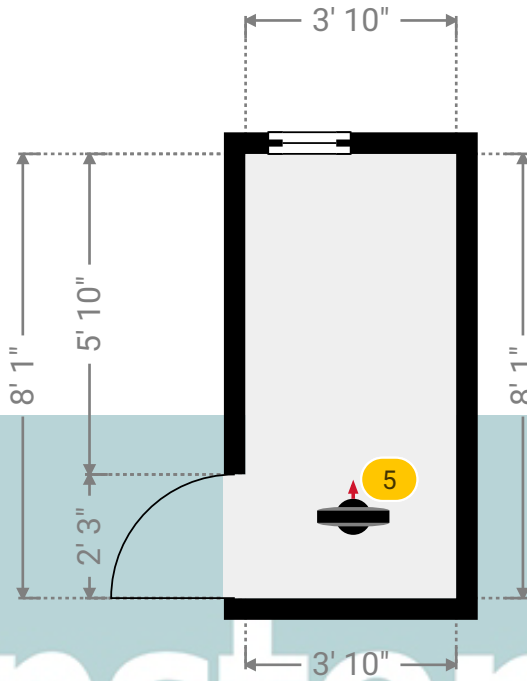
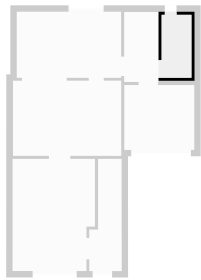

# Kempsters

ESTATE AGENTS

## ▼ Shower/Ground Floor

Photo  
1 Photo (see photos page)

### 5 360 PANORAMA

Photo  
1 Photo (see photos page)



## 18 Sycamore Way

18 Sycamore Way, RM15 6XB South Ockendon, England, United Kingdom  
TOTAL AREA: 916.12 sq ft • LIVING AREA: 916.12 sq ft • FLOORS: 2 • ROOMS: 12

**Kempsters**  
ESTATE AGENTS

### ▼ Photos/Shower

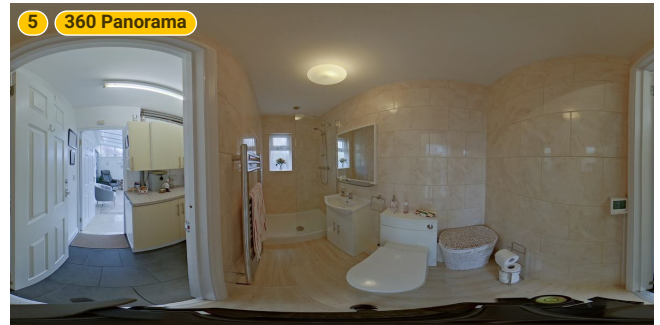

# Kempsters

ESTATE AGENTS

# 18 Sycamore Way

18 Sycamore Way, RM15 6XB South Ockendon, England, United Kingdom  
TOTAL AREA: 916.12 sq ft • LIVING AREA: 916.12 sq ft • FLOORS: 2 • ROOMS: 12



## ▼ Utility Ground Floor

WIDTH: 4' 5" • LENGTH: 9'  
AREA: 39.75 sq ft • PERIMETER: 26' 10"

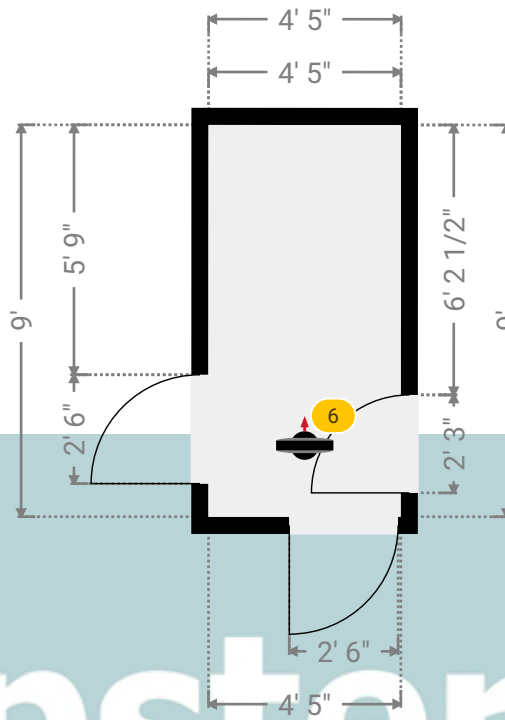
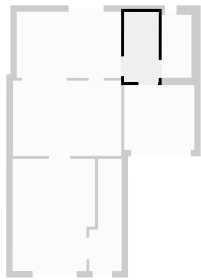

# Kempsters

ESTATE AGENTS

## ▼ Utility/Ground Floor

Photo  
1 Photo (see photos page)

### 6 360 PANORAMA

Photo  
1 Photo (see photos page)



## 18 Sycamore Way

18 Sycamore Way, RM15 6XB South Ockendon, England, United Kingdom  
TOTAL AREA: 916.12 sq ft • LIVING AREA: 916.12 sq ft • FLOORS: 2 • ROOMS: 12

**Kempsters**  
ESTATE AGENTS

### ▼ Photos/Utility



**Kempsters**  
ESTATE AGENTS

# 18 Sycamore Way

18 Sycamore Way, RM15 6XB South Ockendon, England, United Kingdom  
TOTAL AREA: 916.12 sq ft • LIVING AREA: 916.12 sq ft • FLOORS: 2 • ROOMS: 12



## ▼ 1st Floor

TOTAL AREA: 326.25 sq ft • LIVING AREA: 326.25 sq ft • ROOMS: 5

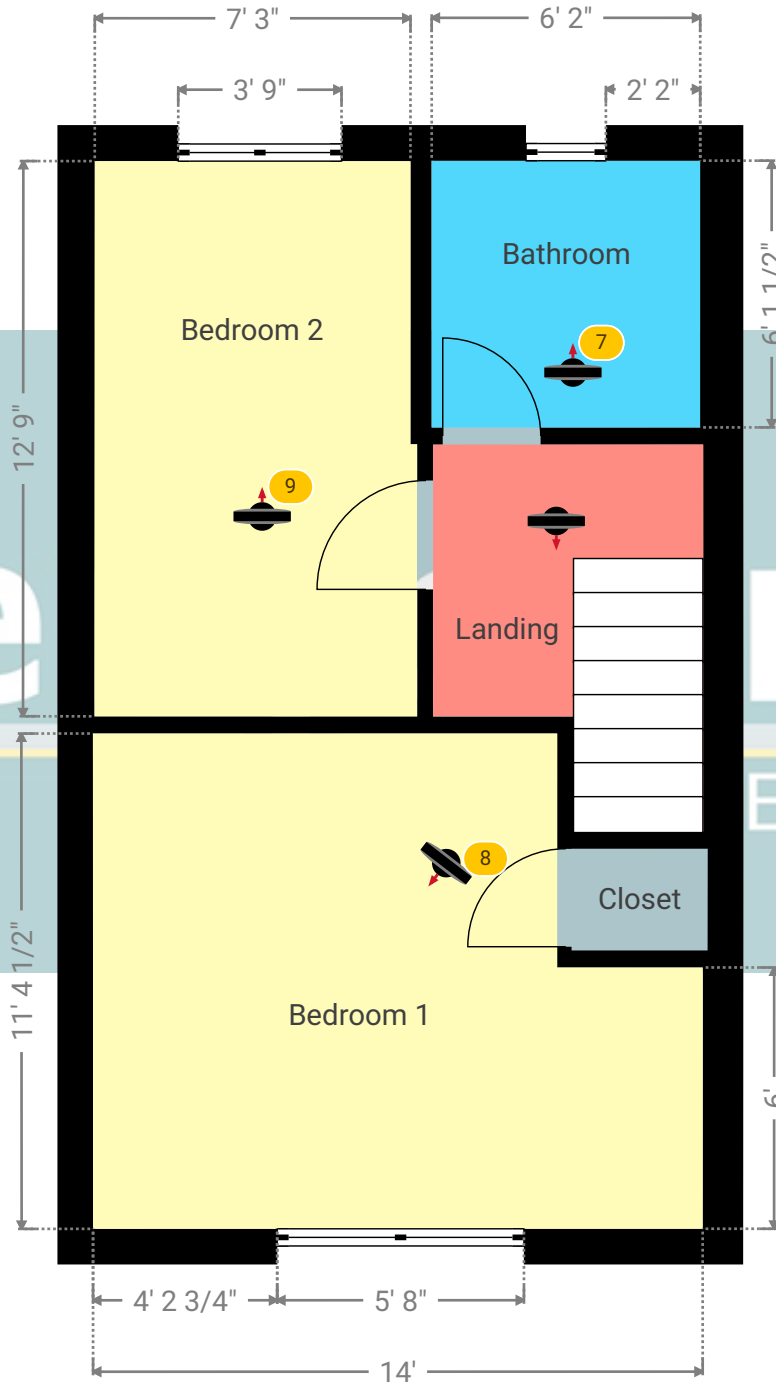

Kempsters Estate Agents take no responsibility for any error, omission, misstatement or use of data shown. This plan is for illustrative purposes only and whilst every attempt has been made to ensure the accuracy of the floorplan shown, all measurements, positioning, fixtures, fittings and any other data shown are an approximate interpretation for illustrative purposes only. These plans are the property of Kempsters Estate Agents Ltd and must not be reproduced in any form without our permission.

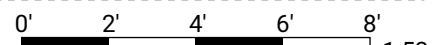

# 18 Sycamore Way

18 Sycamore Way, RM15 6XB South Ockendon, England, United Kingdom  
TOTAL AREA: 916.12 sq ft • LIVING AREA: 916.12 sq ft • FLOORS: 2 • ROOMS: 12



## ▼ Bathroom 1st Floor

WIDTH: 6' 2" • LENGTH: 6' 1 1/2"  
AREA: 37.77 sq ft • PERIMETER: 24' 7"

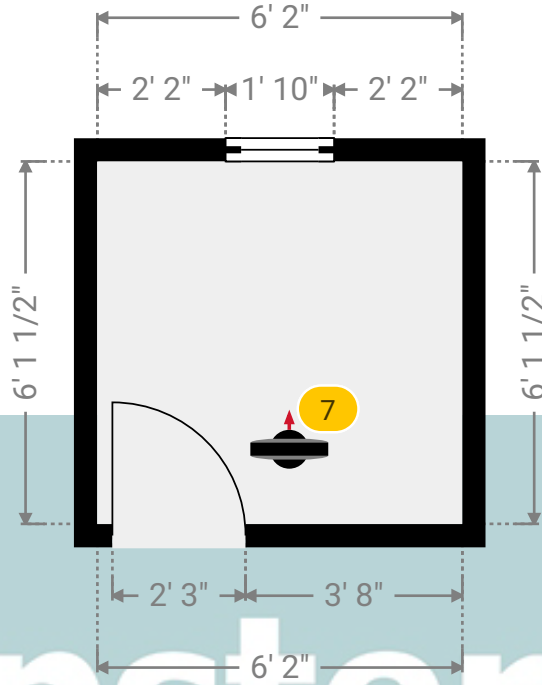
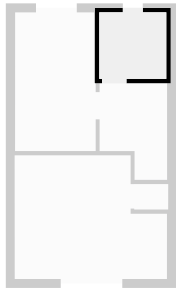

# Kempsters

ESTATE AGENTS

## ▼ Bathroom/1st Floor

Photo  
1 Photo (see photos page)

### 7 360 PANORAMA

Photo  
1 Photo (see photos page)





## 18 Sycamore Way

18 Sycamore Way, RM15 6XB South Ockendon, England, United Kingdom  
TOTAL AREA: 916.12 sq ft • LIVING AREA: 916.12 sq ft • FLOORS: 2 • ROOMS: 12

### ▼ Photos/Bathroom

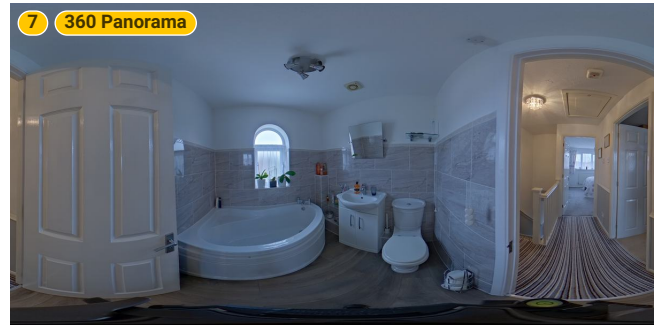

# Kempsters

ESTATE AGENTS

# 18 Sycamore Way

18 Sycamore Way, RM15 6XB South Ockendon, England, United Kingdom  
TOTAL AREA: 916.12 sq ft • LIVING AREA: 916.12 sq ft • FLOORS: 2 • ROOMS: 12



## ▼ Bedroom 1 1st Floor

WIDTH: 14' • LENGTH: 11' 4 1/2"  
AREA: 141.34 sq ft • PERIMETER: 50' 9"

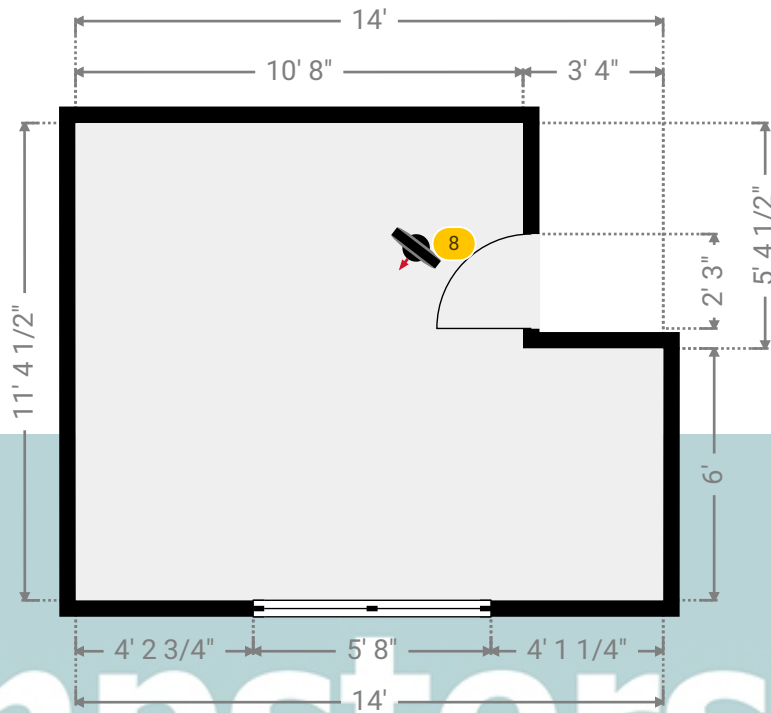
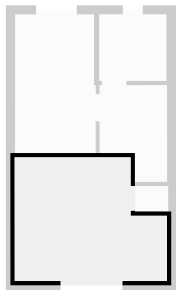

## ▼ Bedroom 1/1st Floor

Photos  
2 Photos (see photos page)

### 8 360 PANORAMA

Photo  
1 Photo (see photos page)



# 18 Sycamore Way

18 Sycamore Way, RM15 6XB South Ockendon, England, United Kingdom  
TOTAL AREA: 916.12 sq ft • LIVING AREA: 916.12 sq ft • FLOORS: 2 • ROOMS: 12



## ▼ Photos/Bedroom 1

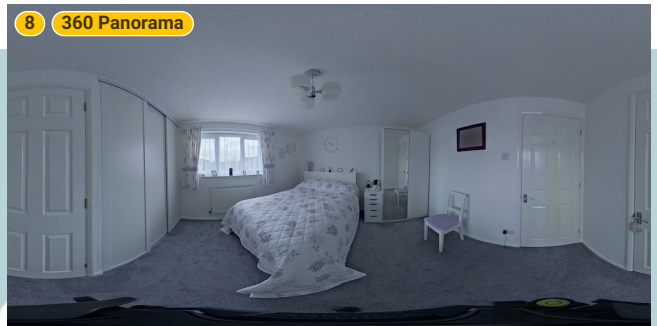

# Kempsters

ESTATE AGENTS

# 18 Sycamore Way

18 Sycamore Way, RM15 6XB South Ockendon, England, United Kingdom  
TOTAL AREA: 916.12 sq ft • LIVING AREA: 916.12 sq ft • FLOORS: 2 • ROOMS: 12



## ▼ Bedroom 2 1st Floor

WIDTH: 7' 5" • LENGTH: 12' 9"  
AREA: 93.48 sq ft • PERIMETER: 40' 4"

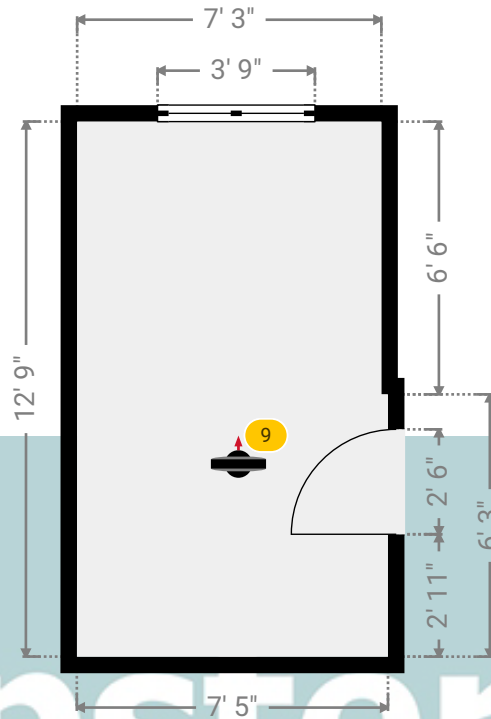
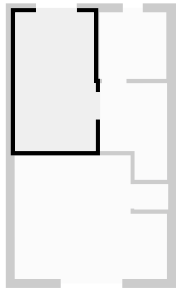

# Kempsters

ESTATE AGENTS

## ▼ Bedroom 2/1st Floor

Photos  
2 Photos (see photos page)

### 9 360 PANORAMA

Photo  
1 Photo (see photos page)



# 18 Sycamore Way

18 Sycamore Way, RM15 6XB South Ockendon, England, United Kingdom  
TOTAL AREA: 916.12 sq ft • LIVING AREA: 916.12 sq ft • FLOORS: 2 • ROOMS: 12



## ▼ Photos/Bedroom 2

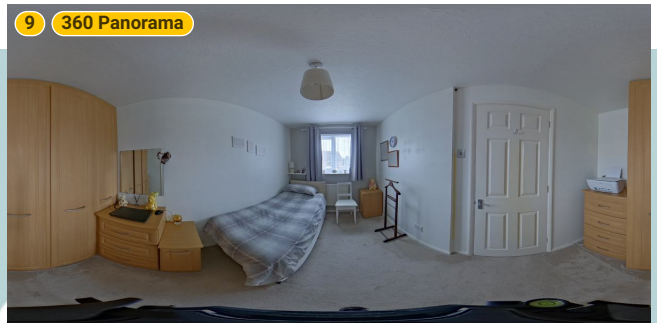
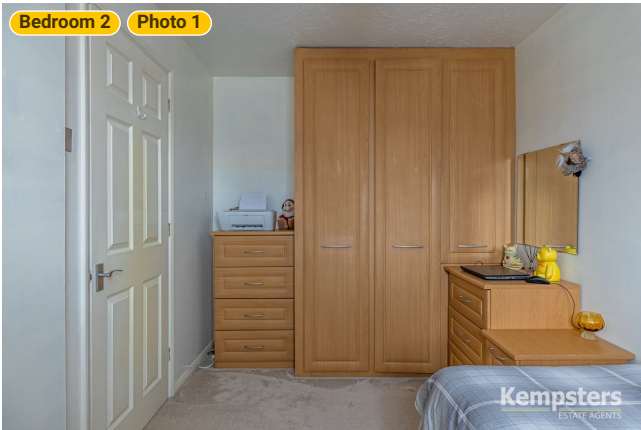

# Kempsters

ESTATE AGENTS

# 18 Sycamore Way

18 Sycamore Way, RM15 6XB South Ockendon, England, United Kingdom  
TOTAL AREA: 916.12 sq ft • LIVING AREA: 916.12 sq ft • FLOORS: 2 • ROOMS: 12



## ▼ Landing 1st Floor

WIDTH: 6' 2 1/2" • LENGTH: 8' 10 3/4"  
AREA: 46.66 sq ft • PERIMETER: 30' 2 1/4"

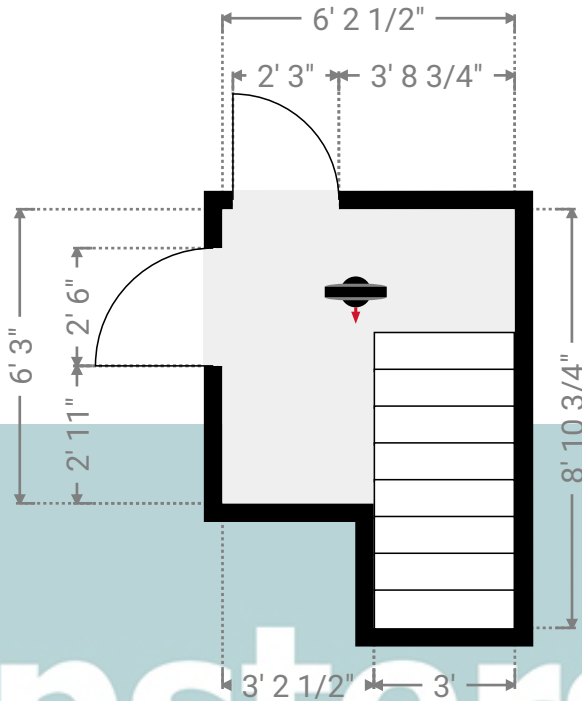
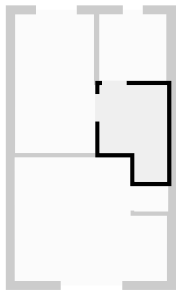

# Kempsters

ESTATE AGENTS

## ▼ Landing/1st Floor

### Photos

2 Photos (see photos page)

# 18 Sycamore Way

18 Sycamore Way, RM15 6XB South Ockendon, England, United Kingdom  
TOTAL AREA: 916.12 sq ft • LIVING AREA: 916.12 sq ft • FLOORS: 2 • ROOMS: 12



## ▼ Photos/Landing



# Kempsters

ESTATE AGENTS