

234 Princess Margaret Road

SUBMITTED BY

Ian
ianhk@icloud.com

CREATED ON

2024-02-27

LOCATION

234 Princess Margaret Road
RM18 8SB Tilbury
England
United Kingdom



Total area
1140.05 sq ft

Floors
2

Rooms
14

Bathrooms
2

Kempsters

ESTATE AGENTS

234 Princess Margaret Road

234 Princess Margaret Road, RM18 8SB Tilbury, England, United Kingdom
TOTAL AREA: 1140.05 sq ft • LIVING AREA: 1140.05 sq ft • FLOORS: 2 • ROOMS: 14



▼ Ground Floor

TOTAL AREA: 643.17 sq ft • LIVING AREA: 643.17 sq ft • ROOMS: 9



Kempsters Estate Agents take no responsibility for any error, omission, misstatement or use of data shown. This plan is for illustrative purposes only and whilst every attempt has been made to ensure the accuracy of the floorplan shown, all measurements, positioning, fixtures, fittings and any other data shown are an approximate interpretation for illustrative purposes only. These plans are the property of Kempsters Estate Agents Ltd and must not be reproduced in any form without our permission.

234 Princess Margaret Road

234 Princess Margaret Road, RM18 8SB Tilbury, England, United Kingdom
TOTAL AREA: 1140.05 sq ft • LIVING AREA: 1140.05 sq ft • FLOORS: 2 • ROOMS: 14



▼ Dining Room Ground Floor

WIDTH: 10' 4 1/4" • LENGTH: 9' 11" • CEILING HEIGHT: 8' 3"
AREA: 102.47 sq ft • PERIMETER: 40' 6"

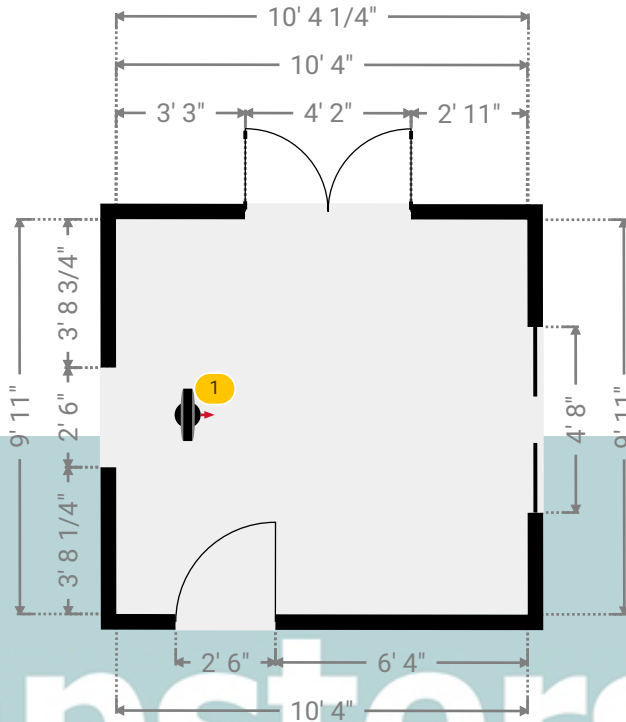
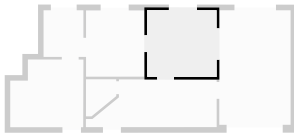

▼ Dining Room/Ground Floor

Photos

2 Photos (see photos page)

1 360 PANORAMA

Photo

1 Photo (see photos page)



234 Princess Margaret Road

234 Princess Margaret Road, RM18 8SB Tilbury, England, United Kingdom

TOTAL AREA: 1140.05 sq ft • LIVING AREA: 1140.05 sq ft • FLOORS: 2 • ROOMS: 14

▼ Photos/Dining Room

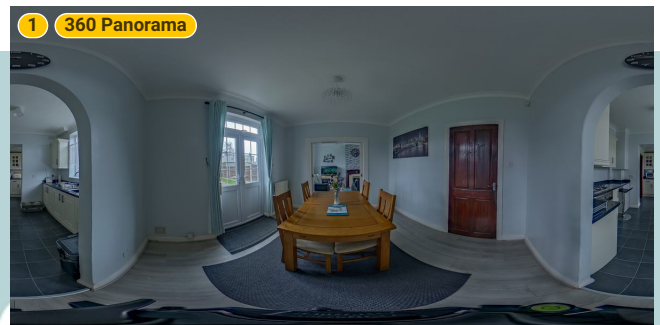
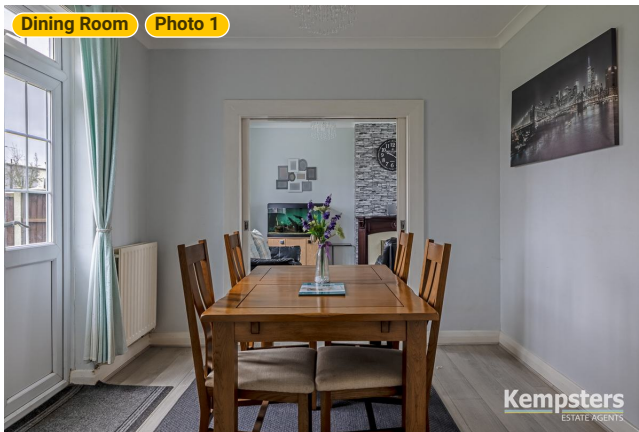

Kempsters

ESTATE AGENTS

234 Princess Margaret Road

234 Princess Margaret Road, RM18 8SB Tilbury, England, United Kingdom
TOTAL AREA: 1140.05 sq ft • LIVING AREA: 1140.05 sq ft • FLOORS: 2 • ROOMS: 14



▼ Hall Ground Floor

WIDTH: 19' 5" • LENGTH: 7' 1 1/4"
AREA: 115.04 sq ft • PERIMETER: 50' 11 1/4"

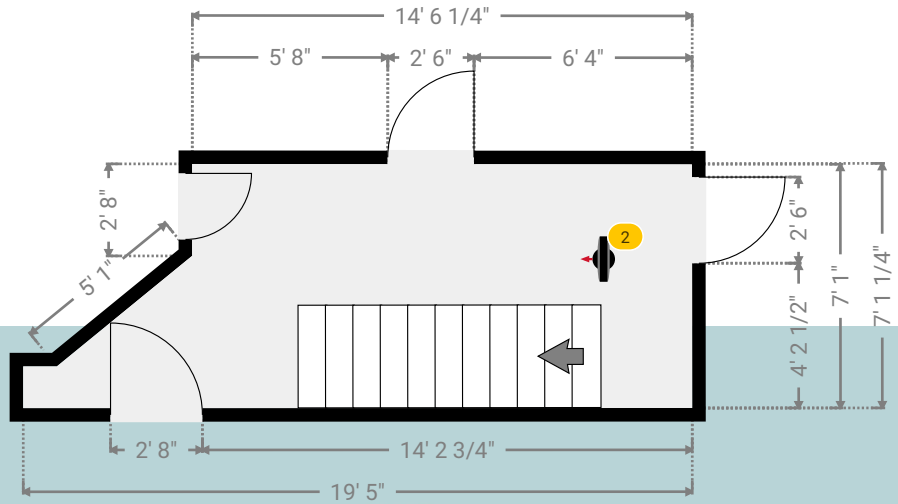
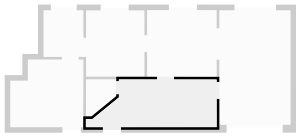

▼ Hall/Ground Floor

Photos
2 Photos (see photos page)

2 360 PANORAMA

Photo
1 Photo (see photos page)



234 Princess Margaret Road

234 Princess Margaret Road, RM18 8SB Tilbury, England, United Kingdom

TOTAL AREA: 1140.05 sq ft • LIVING AREA: 1140.05 sq ft • FLOORS: 2 • ROOMS: 14

▼ Photos/Hall

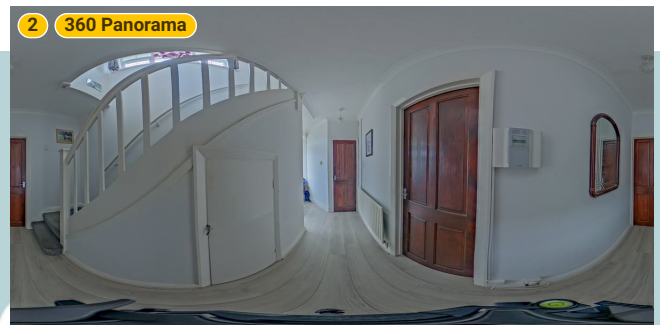
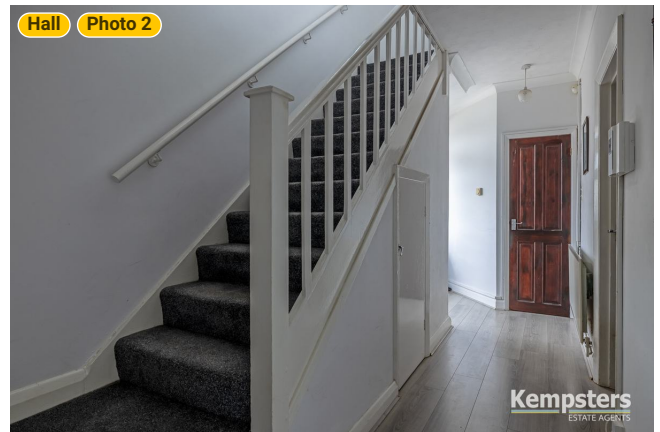
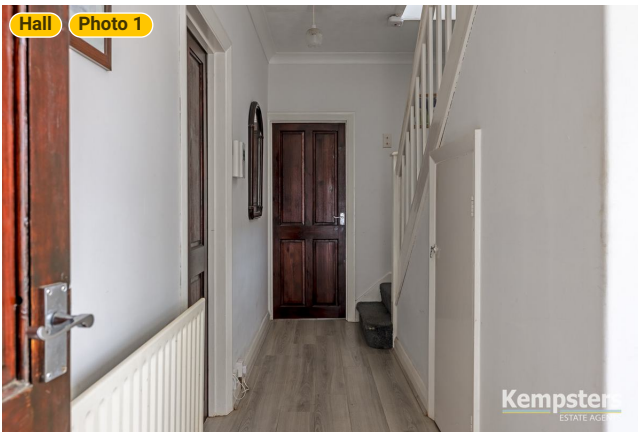

Kempsters

ESTATE AGENTS

234 Princess Margaret Road

234 Princess Margaret Road, RM18 8SB Tilbury, England, United Kingdom
TOTAL AREA: 1140.05 sq ft • LIVING AREA: 1140.05 sq ft • FLOORS: 2 • ROOMS: 14



▼ Kitchen Ground Floor

WIDTH: 8' 8" • LENGTH: 9' 10" • CEILING HEIGHT: 8' 3"
AREA: 85.22 sq ft • PERIMETER: 37'

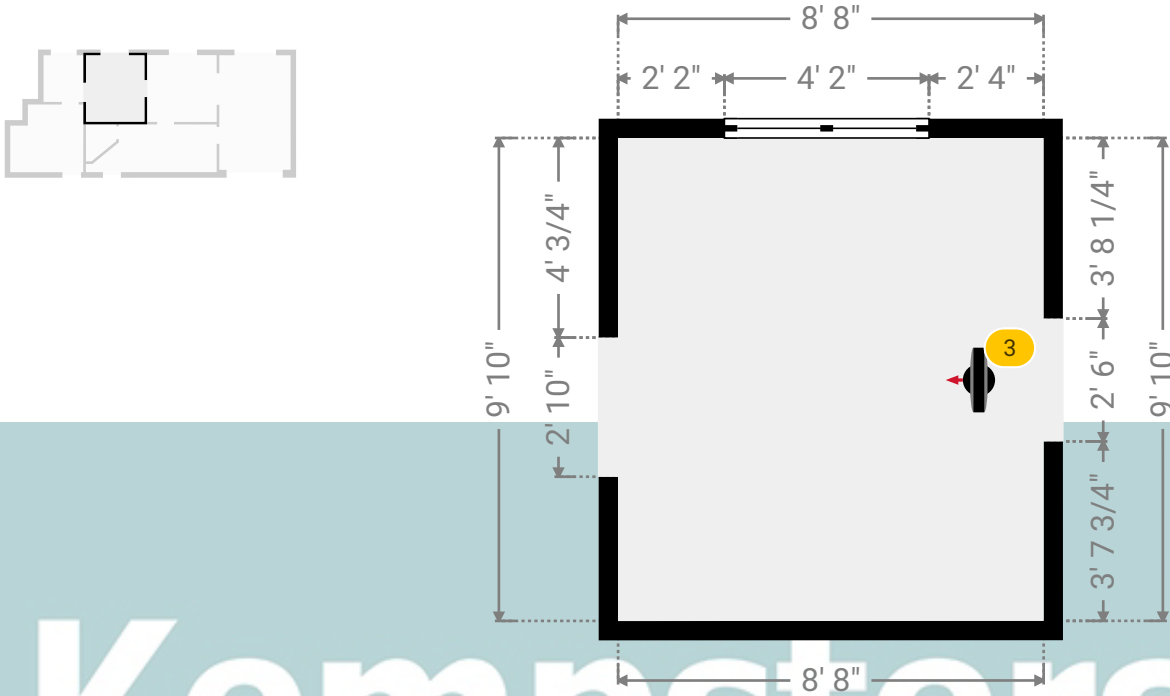

▼ Kitchen/Ground Floor

Photos
4 Photos (see photos page)

3 360 PANORAMA

Photo
1 Photo (see photos page)



234 Princess Margaret Road

234 Princess Margaret Road, RM18 8SB Tilbury, England, United Kingdom

TOTAL AREA: 1140.05 sq ft • LIVING AREA: 1140.05 sq ft • FLOORS: 2 • ROOMS: 14

▼ Photos/Kitchen

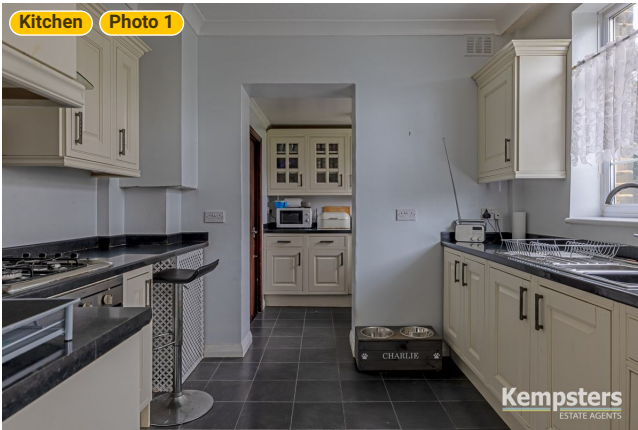

234 Princess Margaret Road

234 Princess Margaret Road, RM18 8SB Tilbury, England, United Kingdom
TOTAL AREA: 1140.05 sq ft • LIVING AREA: 1140.05 sq ft • FLOORS: 2 • ROOMS: 14



▼ Lounge Ground Floor

WIDTH: 10' 7" • LENGTH: 17' • CEILING HEIGHT: 8' 3"
AREA: 179.92 sq ft • PERIMETER: 55' 2"

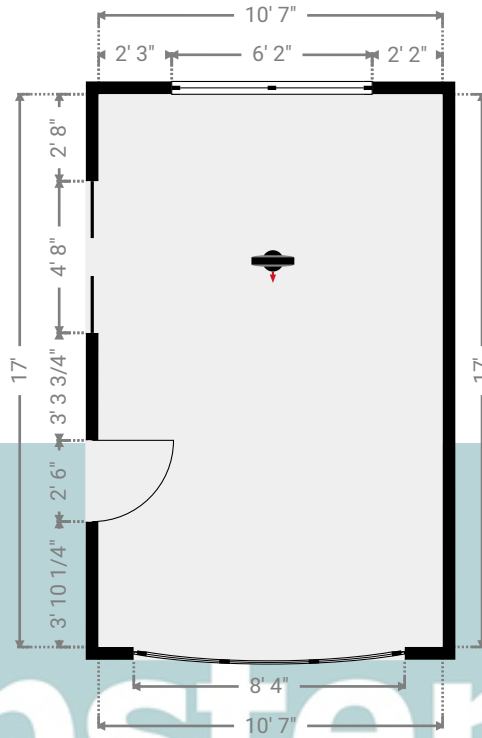
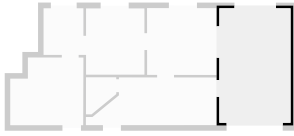

▼ Lounge/Ground Floor

Photos
4 Photos (see photos page)



234 Princess Margaret Road

234 Princess Margaret Road, RM18 8SB Tilbury, England, United Kingdom

TOTAL AREA: 1140.05 sq ft • LIVING AREA: 1140.05 sq ft • FLOORS: 2 • ROOMS: 14

▼ Photos/Lounge



ESTATE AGENTS

234 Princess Margaret Road

234 Princess Margaret Road, RM18 8SB Tilbury, England, United Kingdom
TOTAL AREA: 1140.05 sq ft • LIVING AREA: 1140.05 sq ft • FLOORS: 2 • ROOMS: 14



▼ Reception/Bed 4 Ground Floor

WIDTH: 10' 10 1/4" • LENGTH: 10' 1" • CEILING HEIGHT: 8' 3"
AREA: 100.85 sq ft • PERIMETER: 41' 9 3/4"

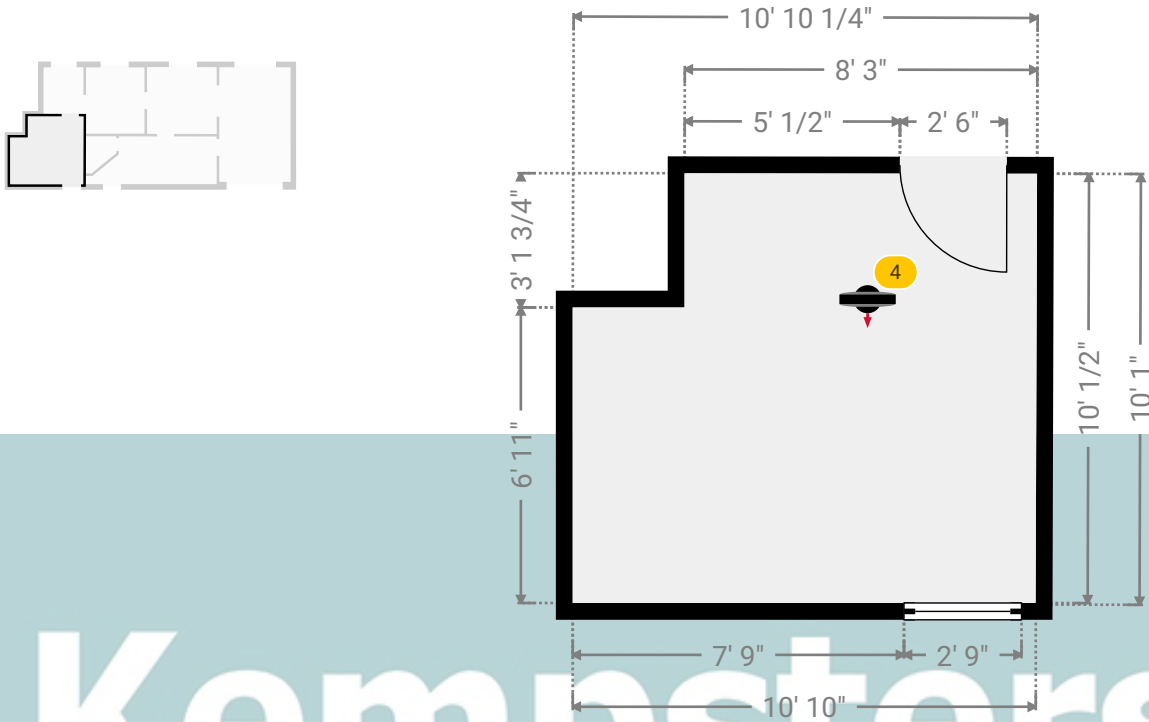

▼ Reception/Bed 4/Ground Floor

Photo
1 Photo (see photos page)

4 360 PANORAMA

Photo
1 Photo (see photos page)



234 Princess Margaret Road

234 Princess Margaret Road, RM18 8SB Tilbury, England, United Kingdom

TOTAL AREA: 1140.05 sq ft • LIVING AREA: 1140.05 sq ft • FLOORS: 2 • ROOMS: 14

Kempsters
ESTATE AGENTS

▼ Photos/Reception/Bed 4

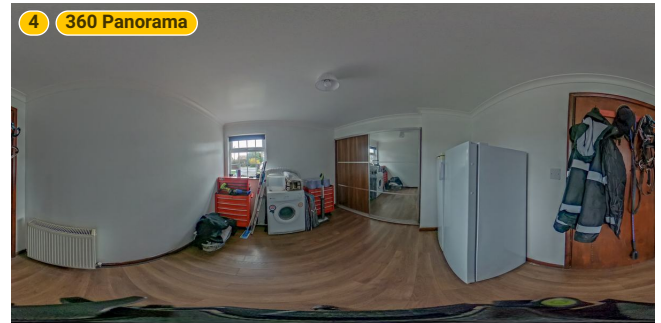

Kempsters

ESTATE AGENTS

234 Princess Margaret Road

234 Princess Margaret Road, RM18 8SB Tilbury, England, United Kingdom
TOTAL AREA: 1140.05 sq ft • LIVING AREA: 1140.05 sq ft • FLOORS: 2 • ROOMS: 14



▼ Toilet Ground Floor

WIDTH: 4' 6" • LENGTH: 5' 6"
AREA: 19.24 sq ft • PERIMETER: 18' 3/4"

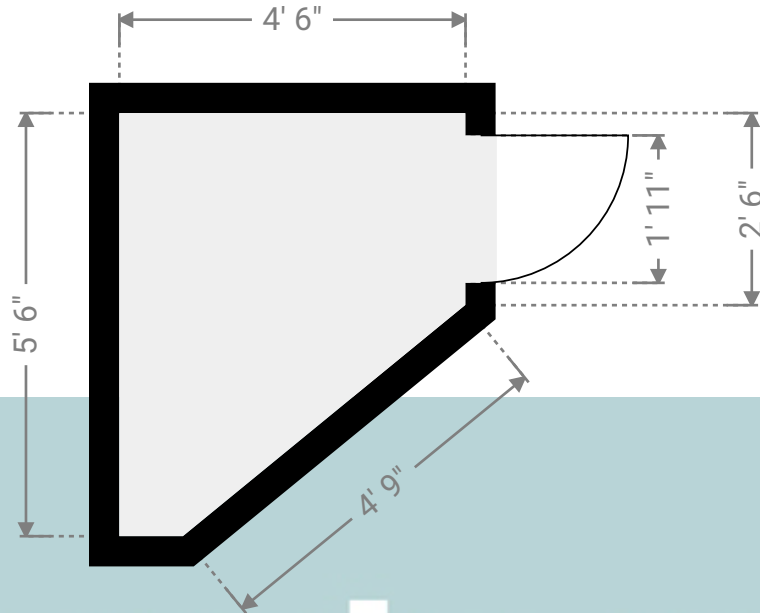
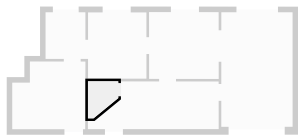

Kempsters

ESTATE AGENTS

▼ Toilet/Ground Floor

Photo
1 Photo (see photos page)

234 Princess Margaret Road

234 Princess Margaret Road, RM18 8SB Tilbury, England, United Kingdom

TOTAL AREA: 1140.05 sq ft • LIVING AREA: 1140.05 sq ft • FLOORS: 2 • ROOMS: 14

Kempsters
ESTATE AGENTS

▼ Photos/Toilet



Kempsters

ESTATE AGENTS

234 Princess Margaret Road

234 Princess Margaret Road, RM18 8SB Tilbury, England, United Kingdom
TOTAL AREA: 1140.05 sq ft • LIVING AREA: 1140.05 sq ft • FLOORS: 2 • ROOMS: 14



▼ Utility Ground Floor

WIDTH: 5' 11" • LENGTH: 6' 11"
AREA: 40.92 sq ft • PERIMETER: 25' 8"

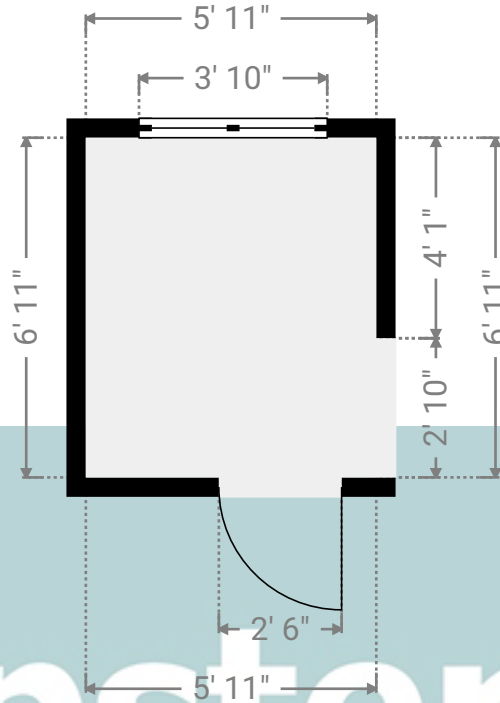
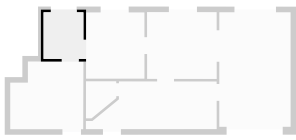

Kempsters

ESTATE AGENTS

▼ Utility/Ground Floor

Photos
2 Photos (see photos page)

234 Princess Margaret Road

234 Princess Margaret Road, RM18 8SB Tilbury, England, United Kingdom

TOTAL AREA: 1140.05 sq ft • LIVING AREA: 1140.05 sq ft • FLOORS: 2 • ROOMS: 14

Kempsters
ESTATE AGENTS

▼ Photos/Utility



Kempsters
ESTATE AGENTS

234 Princess Margaret Road

234 Princess Margaret Road, RM18 8SB Tilbury, England, United Kingdom
TOTAL AREA: 1140.05 sq ft • LIVING AREA: 1140.05 sq ft • FLOORS: 2 • ROOMS: 14



▼ 1st Floor

TOTAL AREA: 496.88 sq ft • LIVING AREA: 496.88 sq ft • ROOMS: 7

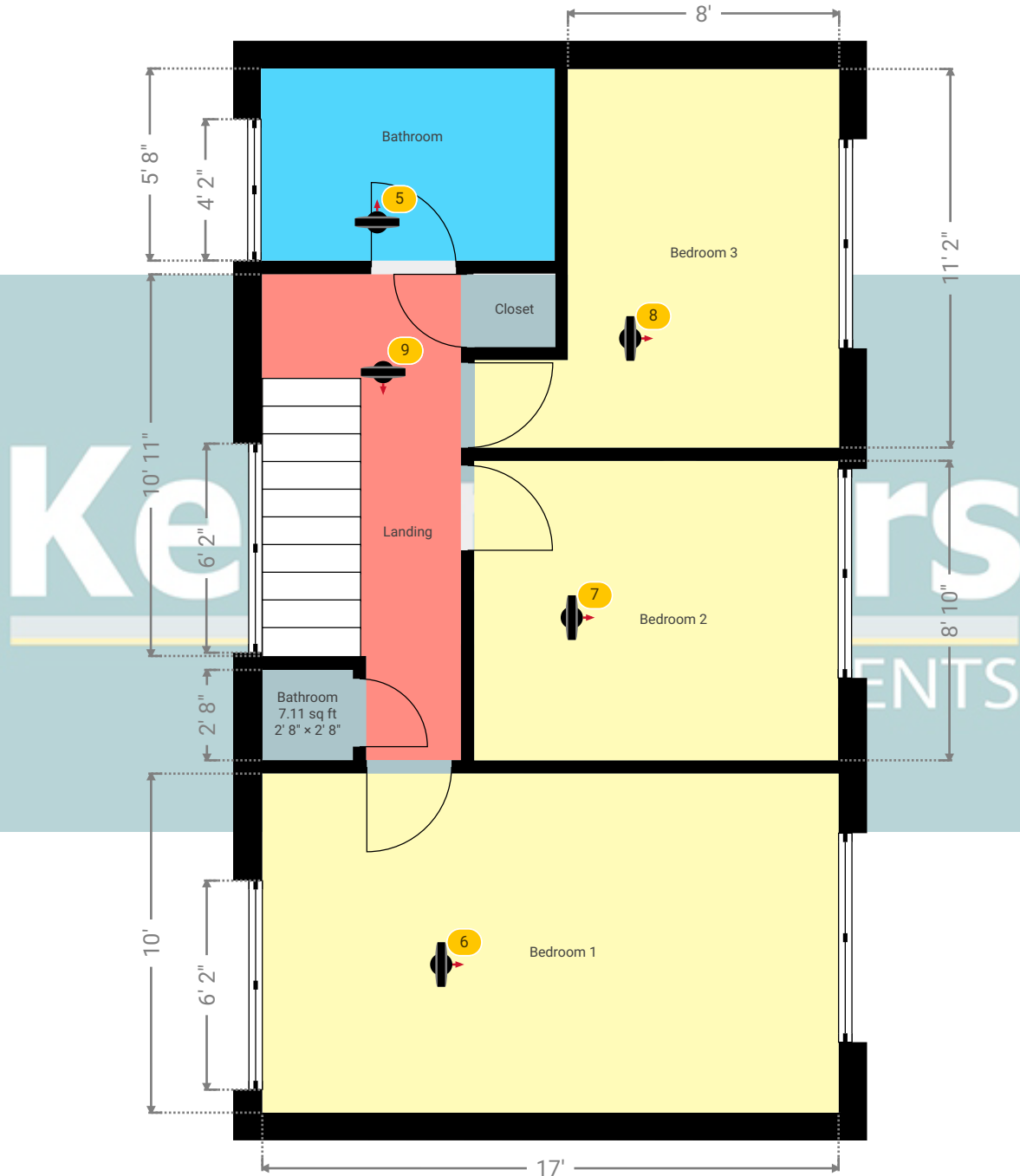

Kempsters Estate Agents take no responsibility for any error, omission, misstatement or use of data shown. This plan is for illustrative purposes only and whilst every attempt has been made to ensure the accuracy of the floorplan shown, all measurements, positioning, fixtures, fittings and any other data shown are an approximate interpretation for illustrative purposes only. These plans are the property of Kempsters Estate Agents Ltd and must not be reproduced in any form without our permission.

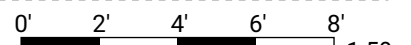

234 Princess Margaret Road

234 Princess Margaret Road, RM18 8SB Tilbury, England, United Kingdom
TOTAL AREA: 1140.05 sq ft • LIVING AREA: 1140.05 sq ft • FLOORS: 2 • ROOMS: 14



▼ Bathroom 1st Floor

WIDTH: 5' 8" • LENGTH: 8' 8" • CEILING HEIGHT: 8' 3"
AREA: 49.11 sq ft • PERIMETER: 28' 8"

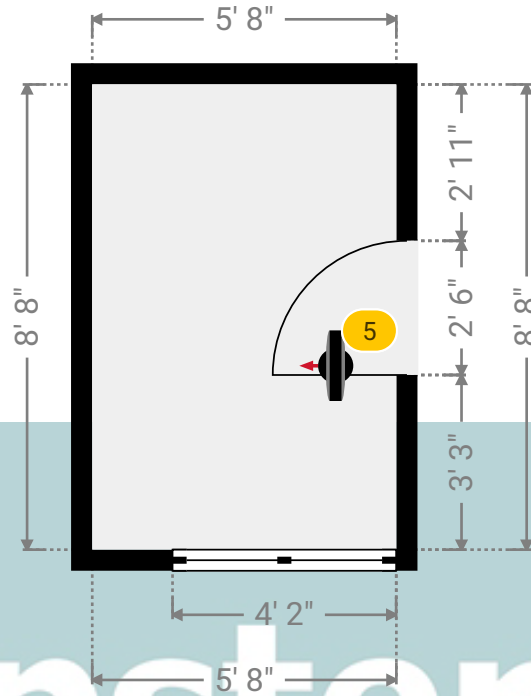
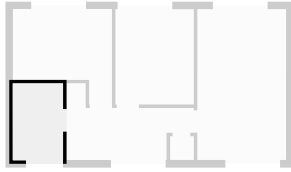

Kempsters

ESTATE AGENTS

▼ Bathroom/1st Floor

Photos
2 Photos (see photos page)

5 360 PANORAMA

Photo
1 Photo (see photos page)



234 Princess Margaret Road

234 Princess Margaret Road, RM18 8SB Tilbury, England, United Kingdom
TOTAL AREA: 1140.05 sq ft • LIVING AREA: 1140.05 sq ft • FLOORS: 2 • ROOMS: 14



▼ Photos/Bathroom

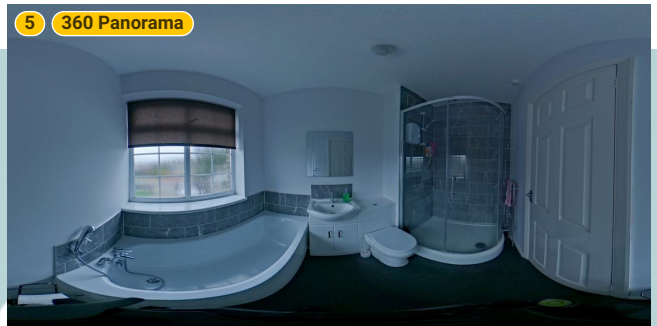
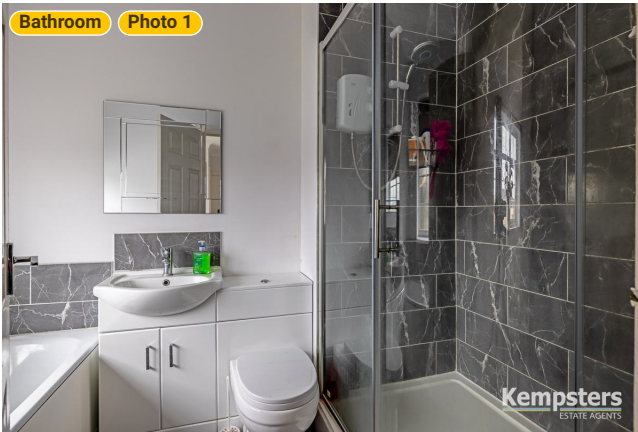

Kempsters

ESTATE AGENTS

234 Princess Margaret Road

234 Princess Margaret Road, RM18 8SB Tilbury, England, United Kingdom
TOTAL AREA: 1140.05 sq ft • LIVING AREA: 1140.05 sq ft • FLOORS: 2 • ROOMS: 14



▼ Bedroom 1 1st Floor

WIDTH: 10' • LENGTH: 17' • CEILING HEIGHT: 8' 3"
AREA: 170.00 sq ft • PERIMETER: 54'

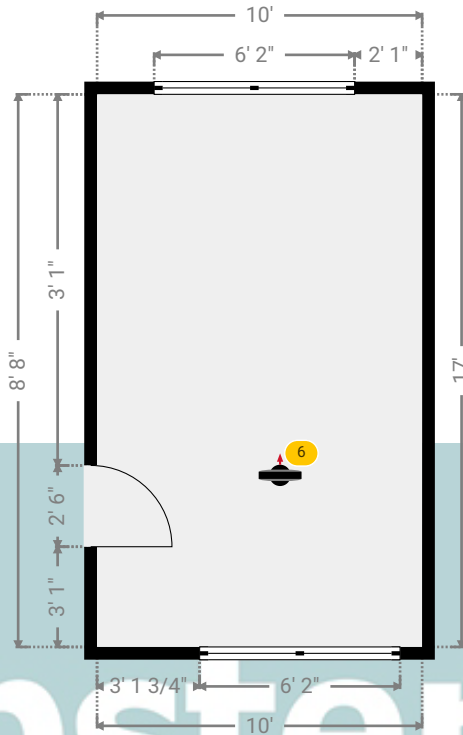
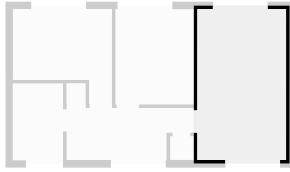

▼ Bedroom 1/1st Floor

Photos
3 Photos (see photos page)

6 360 PANORAMA

Photo
1 Photo (see photos page)



234 Princess Margaret Road

234 Princess Margaret Road, RM18 8SB Tilbury, England, United Kingdom
TOTAL AREA: 1140.05 sq ft • LIVING AREA: 1140.05 sq ft • FLOORS: 2 • ROOMS: 14



▼ Photos/Bedroom 1



234 Princess Margaret Road

234 Princess Margaret Road, RM18 8SB Tilbury, England, United Kingdom
TOTAL AREA: 1140.05 sq ft • LIVING AREA: 1140.05 sq ft • FLOORS: 2 • ROOMS: 14



▼ Bedroom 2 1st Floor

WIDTH: 8' 10" • LENGTH: 10' 8 3/4" • CEILING HEIGHT: 8' 3"
AREA: 94.82 sq ft • PERIMETER: 39' 1 3/4"

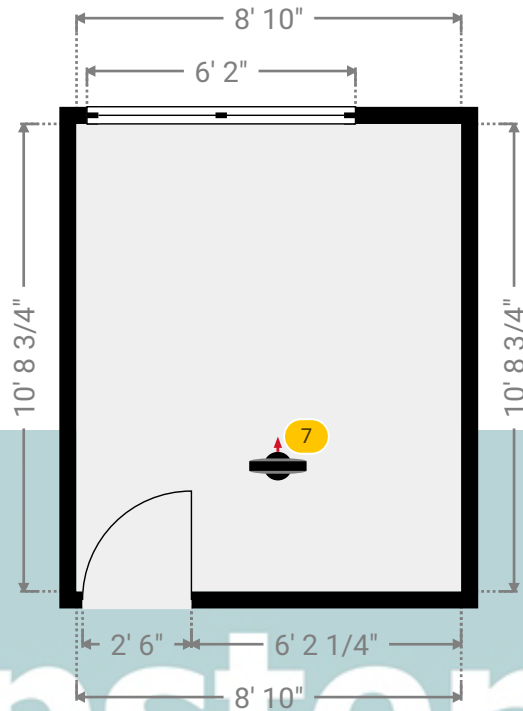
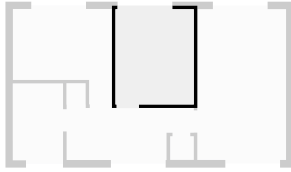

Kempsters

ESTATE AGENTS

▼ Bedroom 2/1st Floor

Photos
2 Photos (see photos page)

7 360 PANORAMA

Photo
1 Photo (see photos page)



234 Princess Margaret Road

234 Princess Margaret Road, RM18 8SB Tilbury, England, United Kingdom

TOTAL AREA: 1140.05 sq ft • LIVING AREA: 1140.05 sq ft • FLOORS: 2 • ROOMS: 14

Kempsters
ESTATE AGENTS

▼ Photos/Bedroom 2

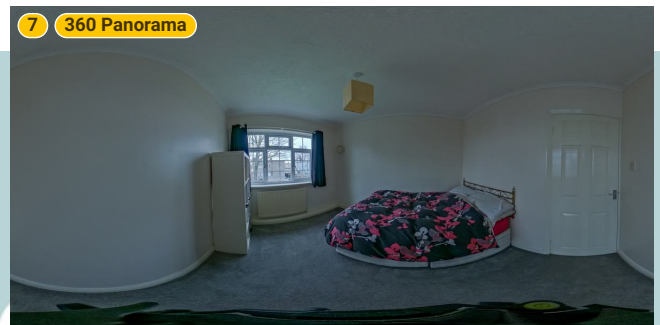
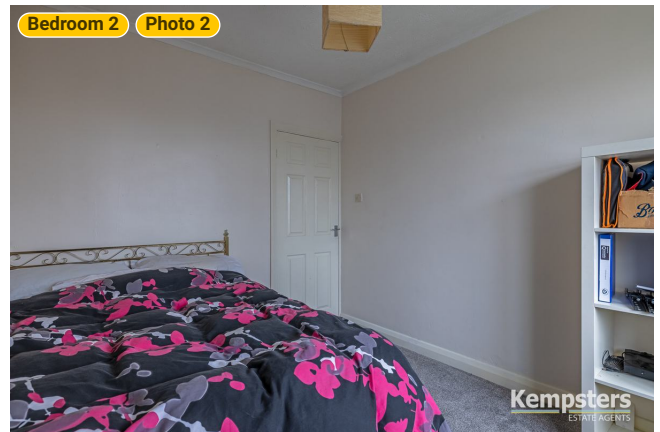
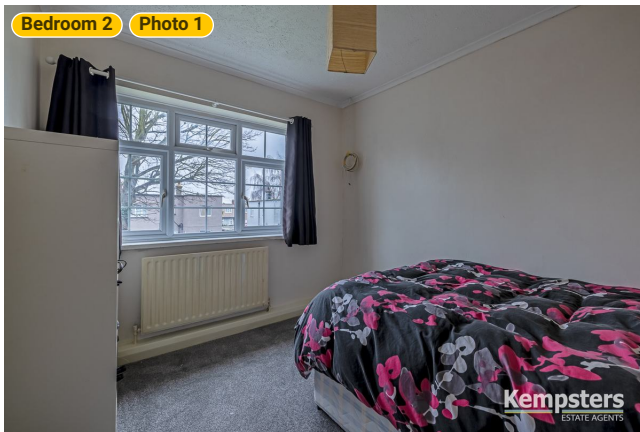

Kempsters
ESTATE AGENTS

234 Princess Margaret Road

234 Princess Margaret Road, RM18 8SB Tilbury, England, United Kingdom
TOTAL AREA: 1140.05 sq ft • LIVING AREA: 1140.05 sq ft • FLOORS: 2 • ROOMS: 14



▼ Bedroom 3 1st Floor

WIDTH: 11' 2" • LENGTH: 10' 9" • CEILING HEIGHT: 8' 3"
AREA: 96.43 sq ft • PERIMETER: 43' 10"

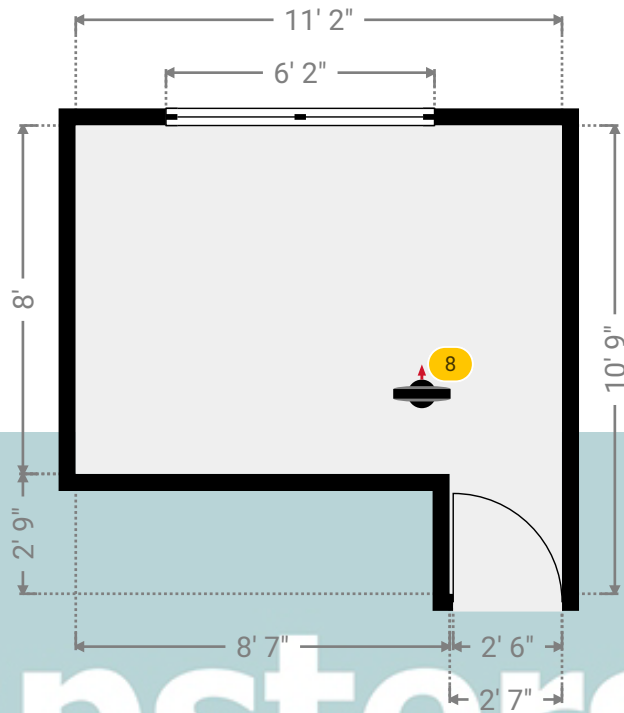
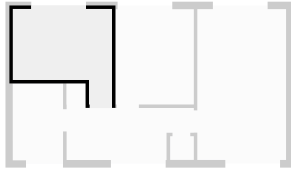

▼ Bedroom 3/1st Floor

Photo
1 Photo (see photos page)

8 360 PANORAMA

Photo
1 Photo (see photos page)



234 Princess Margaret Road

234 Princess Margaret Road, RM18 8SB Tilbury, England, United Kingdom

TOTAL AREA: 1140.05 sq ft • LIVING AREA: 1140.05 sq ft • FLOORS: 2 • ROOMS: 14

Kempsters
ESTATE AGENTS

▼ Photos/Bedroom 3

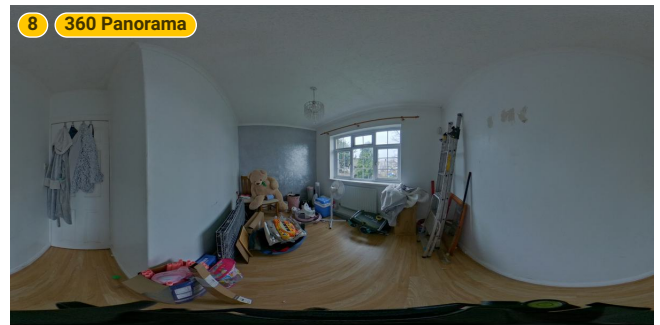

Kempsters

ESTATE AGENTS

234 Princess Margaret Road

234 Princess Margaret Road, RM18 8SB Tilbury, England, United Kingdom
TOTAL AREA: 1140.05 sq ft • LIVING AREA: 1140.05 sq ft • FLOORS: 2 • ROOMS: 14



▼ Landing 1st Floor

WIDTH: 14' 4" • LENGTH: 5' 10 1/2"
AREA: 74.60 sq ft • PERIMETER: 40' 4 3/4"

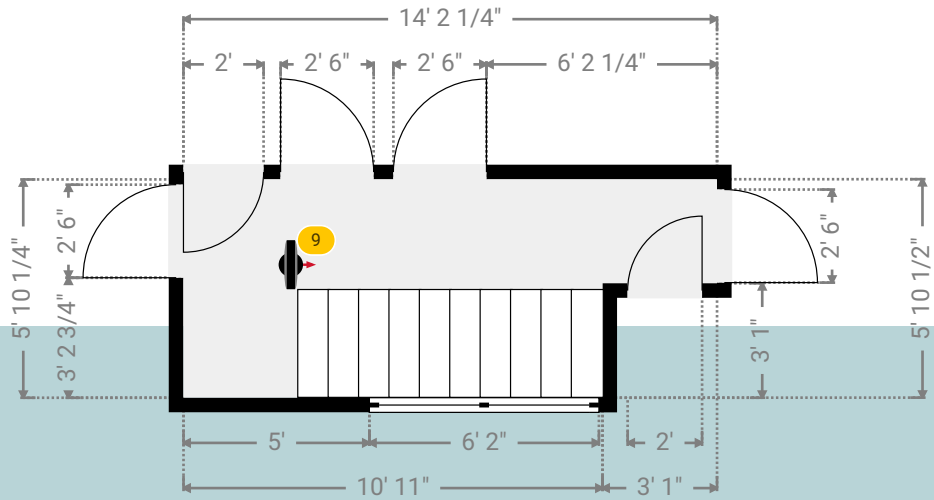
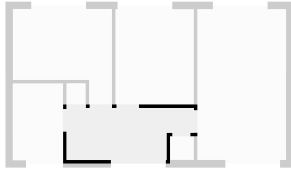

▼ Landing/1st Floor

Photos
2 Photos (see photos page)

9 360 PANORAMA

Photo
1 Photo (see photos page)



234 Princess Margaret Road

234 Princess Margaret Road, RM18 8SB Tilbury, England, United Kingdom

TOTAL AREA: 1140.05 sq ft • LIVING AREA: 1140.05 sq ft • FLOORS: 2 • ROOMS: 14

▼ Photos/Landing

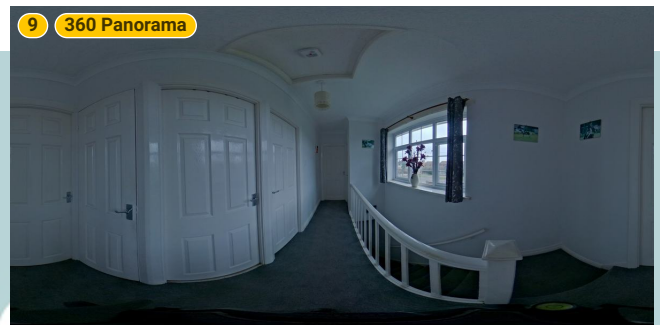
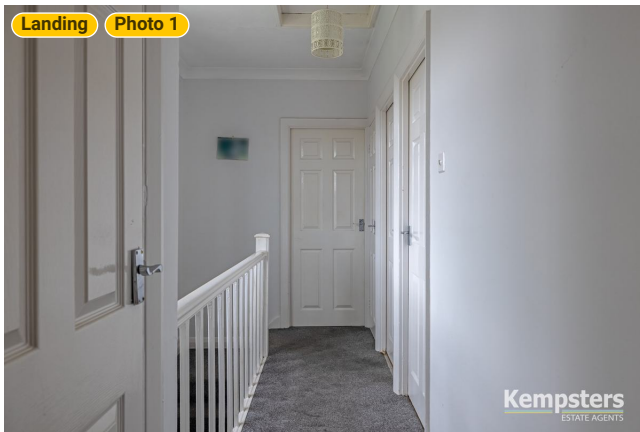

Kempsters

ESTATE AGENTS