



Elliot Heath
ESTATE AGENTS

38 Richmond Close, WARE
Guide Price £495,000

38 Richmond Close

WARE, Ware

Rare opportunity to acquire detached 2-bed home in Ware cul de sac with living/dining room, conservatory, fitted kitchen, shower room, en suite WC. Private garden, garage, gated driveway. Close to amenities and mainline station. Call 01920 293333 to view.

Tenure: Freehold

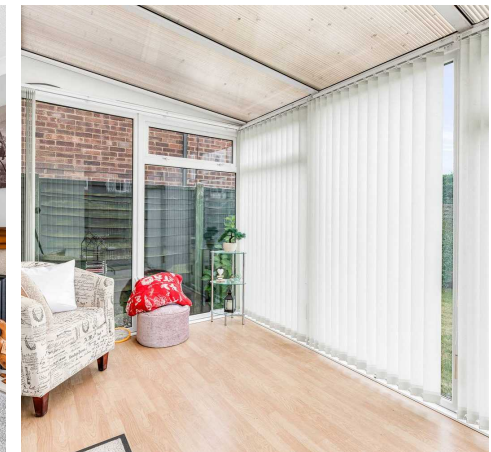
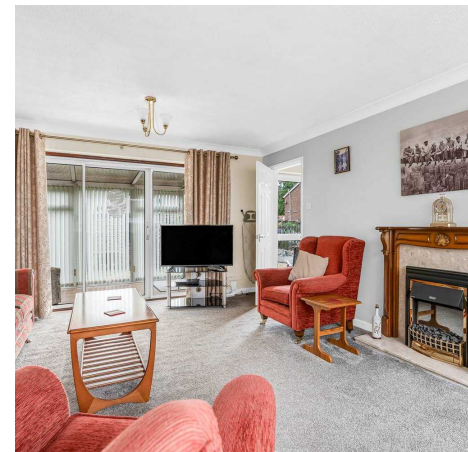
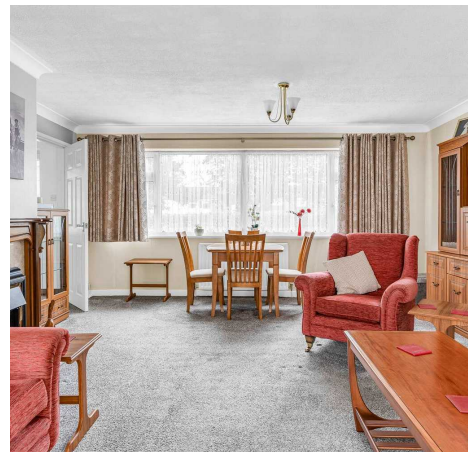

Ground Floor

Approx. 52.5 sq. metres (565.5 sq. feet)

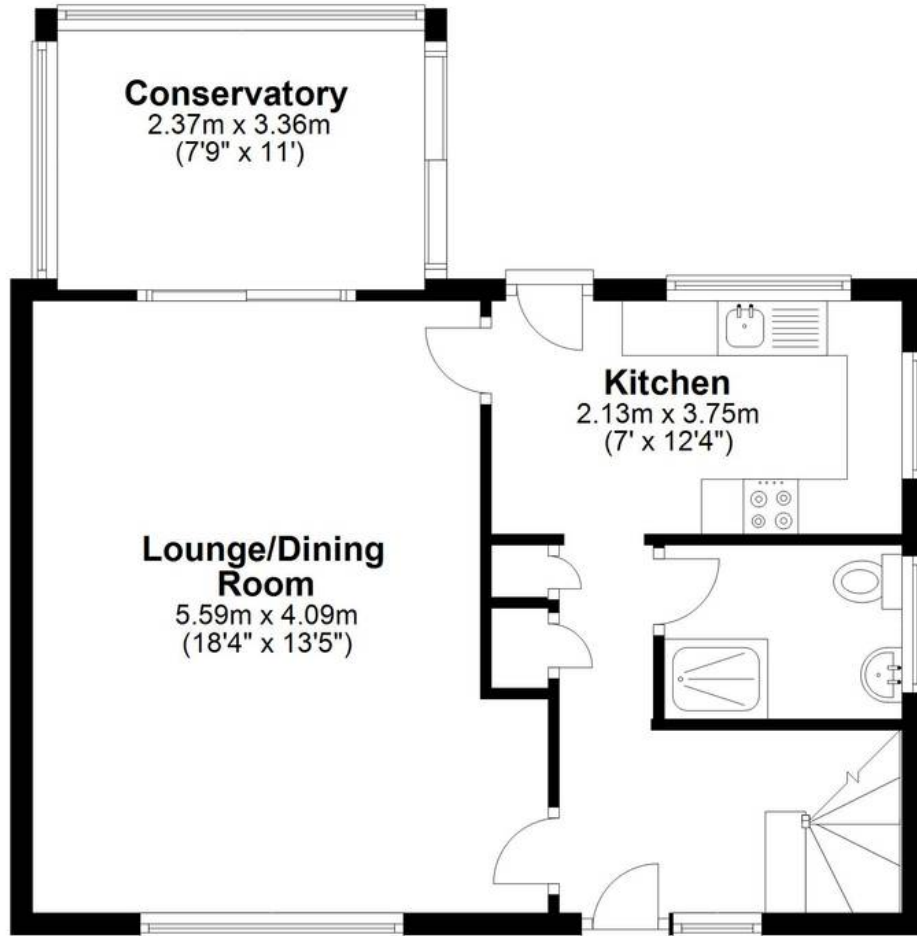

First Floor

Approx. 32.7 sq. metres (351.7 sq. feet)

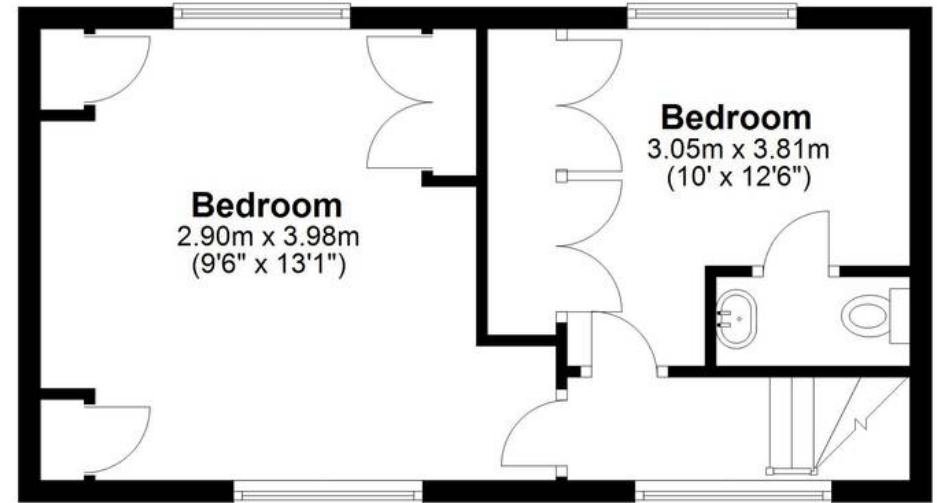

Outbuilding

Approx. 13.7 sq. metres (147.7 sq. feet)

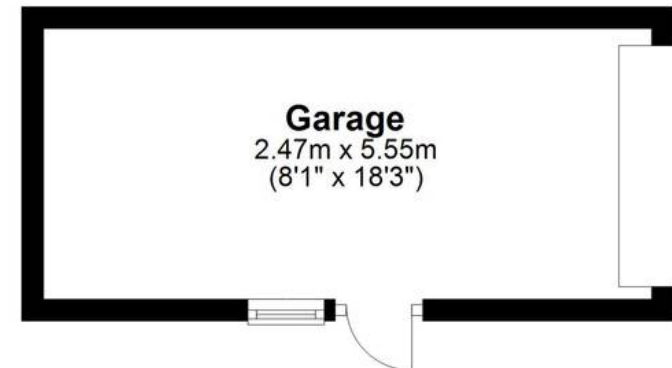

Total area: approx. 98.9 sq. metres (1064.9 sq. feet)

FOR ILLUSTRATIVE PURPOSES ONLY. NOT TO SCALE

Whilst every attempt has been made to ensure the accuracy of the floor plan shown, all measurements, positioning, fixtures, features, fittings and any other data shown are an approximate interpretation for illustrative purposes only and are not to scale. No responsibility is taken for any error, omission, miss-statement or use of data shown.

Property marketing provided by www.matthewkyle.co.uk

Entrance Hall

With double glazed window to front aspect, two built in storage cupboards, radiator, stairs rising to first floor landing, doors to:

Downstairs Shower Room

With double glazed window to side aspect with obscure glass. Fitted with a suite comprising fully tiled shower cubicle, dual flush wc, pedestal wash hand basin, tiled splash back areas, tiled flooring, chrome heated towel rail.

Kitchen

7' 0" x 12' 4" (2.13m x 3.75m)

Dual aspect with double glazed windows to rear and side aspect and door to the rear garden. Fitted with a range of wall and base storage units with work surfaces over incorporating a sink and drainer, built in oven with gas hob and extractor over, appliance space, tiled splash back areas, tiled flooring, radiator, door to:

Lounge/Dining Room

18' 4" x 13' 5" (5.59m x 4.09m)

With double glazed window to front aspect, radiator, feature fireplace, sliding patio doors to:

Conservatory

7' 9" x 11' 0" (2.37m x 3.36m)

Of glazed construction with sliding door to the rear garden, wood effect flooring.

First Floor Landing

With double glazed window to front aspect, doors to:

Bedroom One

9' 6" x 13' 1" (2.90m x 3.98m)

Dual aspect with double glazed windows to front and rear aspect, radiator, fitted with a range of built in wardrobes and storage cupboards.



Bedroom Two

10' 0" x 12' 6" (3.05m x 3.81m)

With double glazed window to rear aspect, radiator, built in wardrobe cupboards, door to:

En Suite WC

Fitted with a suite comprising wc and wash hand basin.





FRONT GARDEN

To the front the property benefits from a low maintenance garden with hedge boundary and gated access to the rear garden.

REAR GARDEN

The rear garden is mainly laid to lawn with patio seating areas and two timber garden sheds. Gated access to the rear to the driveway and detached garage.

GARAGE

Single Garage

The garage has an up and over door and pedestrian access to the rear garden, there is also a gated driveway providing off street parking for one vehicle.

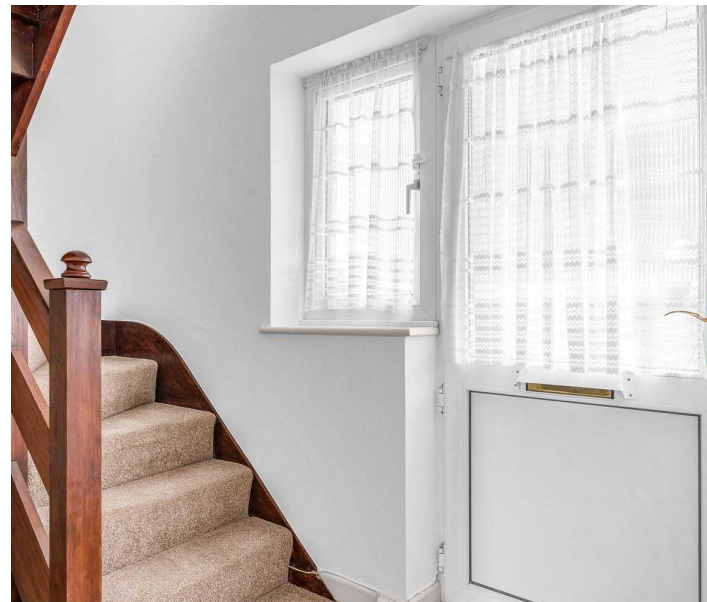





Elliot Heath Estate Agents

Elliot Heath Estate Agents, 7 Star Street - SG12 7AA

01920 29 33 33

hello@elliotheath.co.uk

elliotheath.co.uk